

Profil Katalođu 2020
Profile Catalogue



ALCAS[®]
ALUMINIUM PROFILE SYSTEMS

YALITIMSIZ KAPI&PENCERE

Unisolated Windows and Door

World's new profile systems





Factory / Üretim Tesisi / Çorlu - TEKİRDAĞ



1. Press Line / 2750 US Ton 1. Pres Hattı



2. Press Line / 1800 US Ton 2. Pres Hattı



3. Press Line / 1540 US Ton 3. Pres Hattı



ALCAS® Çorlu - Tekirdağ'da 42.000 m2 arazi üzerinde alüminyum üretimi için özel olarak inşa edilmiş 36.000 m2 kapalı alana sahip tesise sahip olup, uzman 270 personel görev almaktadır. Tesismizde 2.750 Ton 1800 Ton ve 1540 Ton olarak 3 ekstrüzyon presi bulunmaktadır. Yıllık üretim kapasitemiz 22.000 TON olup DU 10 mm'den DU 310 mm'e kadar her türlü profil üretimi yapılabilmektedir. Yüzey işlemsiz pres profilleri 13.6 m.'ye kadar termikleme, paketleme ve sevkiyat imkanı mevcuttur.

Eloksal tesismiz yıllık 11.000 ton profile eloksal yapma kapasitesine sahiptir. Eloksal banyolarımızın boyu 8 m olup net 7.60 cm. uzunluğa kadar olan profiller eloksal yapılabilmektedir. Tesismizde standart 12 mikron kaplamanın yanı sıra isteğe bağlı özel olarak 5 mikrondan 30 mikrona kadar eloksal işlemi yapılabilmektedir. Türkiye'nin en ileri teknolojisine sahip eloksal tesismizde polisajlı parlak profiller, satınel mat profiller ile gümüş, sarı, bronz, siyah renkli eloksalları aynı anda yapmak mümkün olmaktadır. Elektrostatik boya hattımız 36 m fırın uzunluğuna ve çift boya kabineye sahip olup yıllık 7.000 ton alüminyum profilin 180 çeşit RAL renklerinin boyanabildiği hattımızda 7.80 cm. uzunluğa kadar profiller boyanabilmektedir.

Alüminyum profil sistemlerimizin tüm kalıpları fabrikamız bünyesindeki kalıphanemizde gelişmiş CNC makinelerle ve ekipmanlarla donatılmış olup yıllık kalıp üretim kapasitemiz 1.400 adettir.

Firmamızın kendi AR-GE departmanında geliştirmekte olduğu sistemlerin kalıpları, büyük bir hassasiyetle üretilmekte çeşitli test aşamalarından sonra profil üretimine girilmektedir.

Kesme, delme, bükme, çapak alma, barkodlama gibi işlemlerin yapılabildiği gelişmiş makina parkına sahip konfeksiyon hattımızda, müşterilerimizin talep ettiği her türlü profil işleme işleri yapılmakta ve isteğe uygun olarak paketlenmektedir. İmalatımız da 6063,6060 ,6061,6005, 6082 alaşımı hammaddeden F18 den F31 e kadar çeşitli sertlikte ,su soğutmalı üretim yapabilmekteyiz. Ürettiğimiz tüm ürünler DIN 12020, 12021, 12022 normlarına uygundur.

Alüminyum giydirme cephe, kapı, pencere sektöründe uzman olan firmamızın tesismizdeki üretimini %65'i kapı, pencere, cephe profilleri gibi mimari ürünlerden oluşmaktadır. Mimari ve mühendislerden oluşan 12 kişilik teknik ekibimiz yeni sistemler üretmekte, varolan sistemleri de geliştirmektedir. Tüm sistemlerimiz çeşitli deneyler ve testlerden geçirilmekte sorunsuz ürünü size ulaştırmayı hedefleyen ARGE departmanımız sizlerden gelecek her türlü talebi hızla yerine getirmeye hazırdır. Üretimimizin %67'ini başta Amerika ve Avrupa ülkeleri olmak üzere 28 ülkeye ihraç eden firmamızın yurt içinde de 300'ü aşkın bayii ve kurumsal müşteriye hizmet vermektedir. Şirketimiz birçok ülkede bulunan bağılantı ve ofislerimiz vasıtasıyla hızlı, yerel ve güvenilir hizmet sunmaktadır.

TSE, GOST, GOST-R, CE, CPTP, ISO 9001:2008, QUALONAT, QUALICOAT, IFT ROSENHEIM, ISO 18001, ISO 14001, IATF 16949, EN 15088 gibi bir çok kalite ve standartlar belgesine sahip fabrikamızın yüksek kapasitesi, profil serilerindeki geniş yelpaze ve üretim tecrübesi ile sizlere en iyi profil ve profil sistemlerini sunmaya hazırdır.

ALCAS® ALUMINIUM PROFILE SYSTEMS 270 qualified personnel is working in the factory which is specially built and landed on a total area of 42.000 m2 and a closed area of 36.000 m2 in Çorlu Tekirdağ. We have two extrusion presses in the factory, 2.750 UST 1800 UST and 2540 UST. The annual production capacity is 22.000 tons and all kind of profiles which have width of 10 mm to 310 mm can be produced. Max. Mill Finish surface aged to T6 profile length is 13.6 meters.

Our anodic oxidation plant has got the capacity of making 11.000 tons of profile anodic oxidation annually. The length of our anodic oxidation baths is 8 meters and there the profiles till the length of 7.60 cm net can be made anodic oxidation. In our plant besides the standard 12 micron of coating, the anodic oxidation process from 5 micron to 30 micron depending on the request can be made peculiarly. It is possible to make polished luminous profiles, satin opaqued profiles and silver, yellow, bronze, black colored anodic oxidations at the same time in our anodic oxidation plant having the latest technology of Turkey. Our electrostatic paint line has got an oven length of 3x6 meters and double paint cabins and the profiles until the length of 7.80 cm can be painted in our line in which 180 kinds of RAL colors of 7.000 tons of aluminum profiles can be painted.

All the moulds of our aluminum profile systems are made with the developed CNC machine tools and equipments in our molding room present within the constitution of our factory and our annual capacity of mould production is 1.400 pieces. The molds of the systems which are developed in its own Research & Development department of our firm are produced with great precision and the profile production is started following various test stages. All kinds of profile processing works requested by our

customers are made in our confection line having the developed machinery line where the processes such as cutting, boring, bending, burr removing, bar coding can be made and are packed in conformity with the demand.

We can make water cooled production in various hardness in our production from 18 to 31 of the 6063, 6060, 6061, 6005, 6082 alloyed raw materials. All the products that we produce are in conformity with the norms of DIN 12020, 12021, 12022.55% of the production in our plant of our firm that is experienced in the aluminum curtain wall, door, window sectors consist of the architectural products such as doors, windows, face wall profiles. Our technical team of 12 persons consisted of Architectures and Engineers produce new systems and change the currently existing systems. All of our systems are being passed through various experiments and tests and our Development & Search department which aims to reach the products without any problem to you, is ready to perform any kind of demand to be received from you rapidly. Our company which exports 70% of its production to 28 countries to the European countries and USA at the first hand also has been giving service to vendors and corporate customers exceeding 300 inside the country. Our company, through our offices in many countries, and the connection fast, local and reliable service provides.

Our factory, which has got a lot of certificates of quality and standards like TSE, GOST, GOST-R, CE, CPTP, ISO, QUALONAT, QUALICOAT, IFT ROSENHEIM, ISO 18001, ISO 14001, IATF 16949, EN 15088 is ready to submit you the best profiles and profile systems along with its high capacity, its wide range at the profile series and the production experience.

Shipping and Packaging / Sevkiyat ve Paketleme



Shipping and Packaging / Sevkiyat ve Paketleme



Die Shop / Kalıphane



Mechanical Processes / Mekanik İşlemler



Electrostatic Paint Line / Elektrostatik Boya Hattı



Anodizing Line / Eloksal Hattı



Die Archive / Kalıp Arşivi



Wood Coating Unit / Ahşap Kaplama Ünitesi

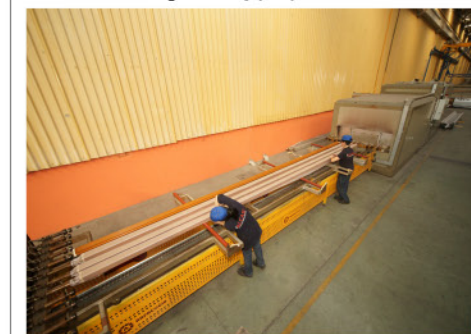

Mechanical Processes / Mekanik İşlemler



Project Name / Proje Adı : Cankar Tekstil
System / Sistem : AWR57
City / Şehir : Laleli - İstanbul - TÜRKİYE



ALCAS®



AWR57

Alcas 57 mm Window-Door System
Alcas 57 mm Kapi-Pencere Sistemi



ALCAS' AWR57 serisi oval dış formu ile yalıtım gerekmeyen mekanlarda hem estetik hemde ekonomik bir çözümdür, farklı kasa kanat ve yardımcı profilleri ile sınırsız çözümler sunarak uygulayıcıya kolaylık sağlar.

AWR57 serisindeki kanat ve kasa profilleri 1.5- 2 mm kalınlıkları ile çok farklı ölçülerde doğrama ve çok çeşitli aksesuarların uygulanabilme özelliği ile de istenen şekilde doğramaların yapılabilmesi sağlanmaktadır, sistem içerisinde kullanılan bir çok profil ve aksesuarlar **ALCAS'** sistemleri içerisindeki diğer sistemlerle uyumlu olduğu için kullanıcı ve satıcıların stok maliyetlerini düşürmektedir.

ALCAS' AWR57 series have got two different sizes as 55 and 64 mm. The outer appearances of our series have got an elegant radius form. Both of the series are produced in the thickness of 1.5 and 2 mm.

AWR57 series use the same lath, corner wedge, adaptor profiles, seals and accessories with the AW series which are our other series and hinder the conflict between the stock and production for the applications.

Descriptions / Tanımlamalar

		Profile type description Profil tip tanımlamaları	
A Brand ALCAS'	Marka ALCAS'	F Frame	Kasa
WR System Type Window	Sistem Tipi Pencere	M Meeting Rail	Orta Kayıt
57 Series Length	Seri Genişliği	V Vent	Kanat
F Profile Type	Profil Tipi	A Adapter	Adaptör
01 Group Location	Gruptaki Yeri	C Cover	Kapak
		K Basalt	Tekmelik
		G Glazing Bead	Cam Çıtası

Symbols / Semboller

	Corner block assembly with 45° cutting process 45° kesim işlemi köşe takozu ile birleştirme
	Milling process of merging with the vertical connection Kertme işlemi dik bağlantı ile birleştirme
	Cross-sectional aspect of strength Mukavemet kesit yönü

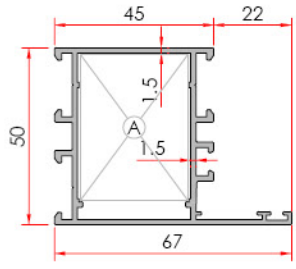

Wide Frame
Geniş Kasa

System Code	Profile No	Weight kg/m
AW50 F 1501	1301	1.121
Jxx cm ⁴	10.7	Jyy cm ⁴ 16.7
	A	AKB-1329-41.6

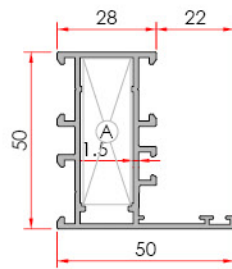

Narrow Frame
Dar Kasa

System Code	Profile No	Weight kg/m
AW50 F 1502	1302	0.973
Jxx cm ⁴	11.4	Jyy cm ⁴ 4.3
	A	AKB-1328-41.6

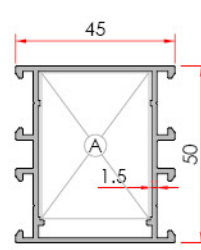

Frame
Kasa

System Code	Profile No	Weight kg/m
AW50 F 1503	1300	0.976
Jxx cm ⁴	11.6	Jyy cm ⁴ 8.9
	A	AKB-1329-41.6
	A	AOB-1323-28.6
	A	AOB-1324-30.8

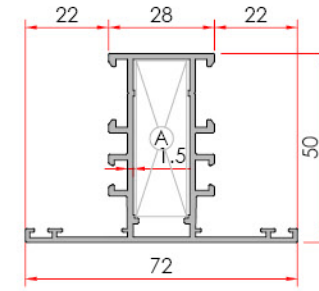

Narrow Meeting Rail
Dar Orta Kayıt

System Code	Profile No	Weight kg/m
AW50 M 1502	1305	1.071
Jxx cm ⁴	12.0	Jyy cm ⁴ 8.5
	A	AKB-1328-41.6
	A	AOB-1323-11.6
	A	AOB-1324-13.8

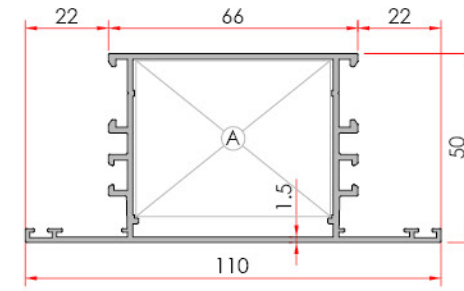

Meeting Rail
Geniş Orta Kayıt

System Code	Profile No	Weight kg/m
AW50 M 1503	1303	1.391
Jxx cm ⁴	19.1	Jyy cm ⁴ 41.9
	A	AKB-1330-41.6
	A	AOB-1323-49.6
	A	AOB-1324-51.8

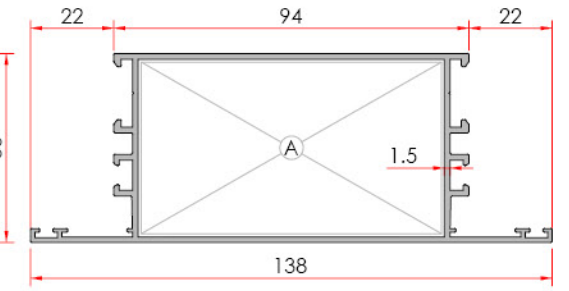

Base Meeting Rail
Baza Orta Kayıt

System Code	Profile No	Weight kg/m
AW50 M 1504	1311	1.607
Jxx cm ⁴	24.0	Jyy cm ⁴ 87.9
	A	AOB-1323-80.5
	A	AOB-1324-80.5

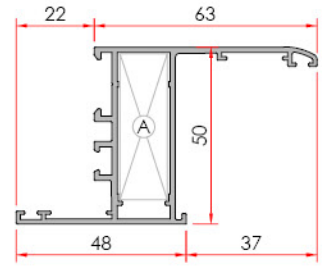

Sill Frame
Pervaz Kasa

System Code	Profile No	Weight kg/m
AW50 F 1504	1786	1.077
Jxx cm ⁴	21.0	Jyy cm ⁴ 5.7
	A	AKB-1328-41.6

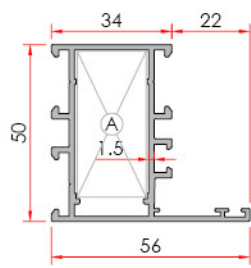

Wide Frame
Geniş Kasa

System Code	Profile No	Weight kg/m
AW50 F 1505	1788	1.018
Jxx cm ⁴	12.8	Jyy cm ⁴ 6.3
	A	AKB-1730-41.6

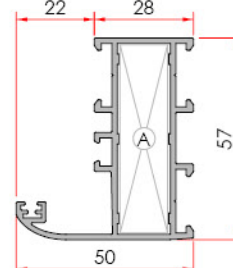

Narrow Frame
Dar Kasa

System Code	Profile No	Weight kg/m
AWR57 F 1501	1900	1.077
Jxx cm ⁴	15.8	Jyy cm ⁴ 5.6
	A	AKB-1328-52.6

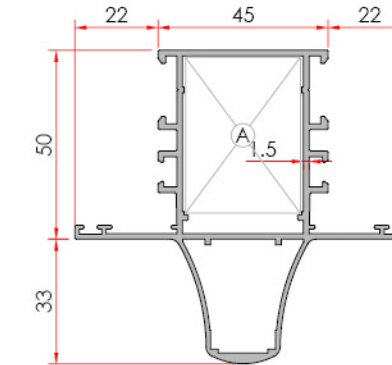

Reinforced Meeting Rail
Takviyeli Orta Kayıt

System Code	Profile No	Weight kg/m
AW50 M 1505	1372	1.565
Jxx cm ⁴	32.3	Jyy cm ⁴ 20.8
	A	AOB-1323-28.6
	A	AOB-1324-30.8

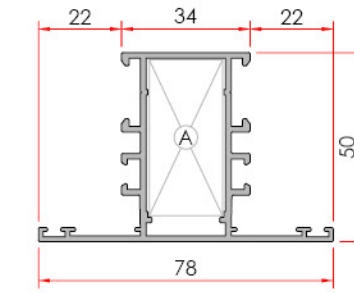

Meeting Rail
Orta Kayıt

System Code	Profile No	Weight kg/m
AW50 M 1506	1787	1.123
Jxx cm ⁴	11.7	Jyy cm ⁴ 13.2
	A	AKB-1730-41.6
	A	AOB-1323-17.6
	A	AOB-1324-19.8

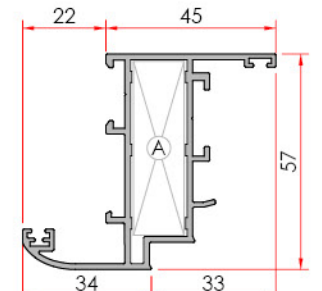

Narrow Vent
Dar Kanat

System Code	Profile No	Weight kg/m
AWR 57 V 1501	1902	1.093
Jxx cm ⁴	20.2	Jyy cm ⁴ 4.9
	A	AKB-1328-46.4

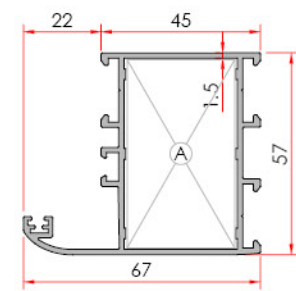

Frame
Kasa

System Code	Profile No	Weight kg/m
AWR57 F 1502	1901	1.188
Jxx cm ⁴	13.3	Jyy cm ⁴ 21.9
	A	AKB-1329-52.6

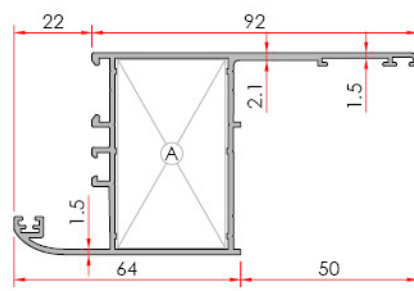

Sill Frame
Pervaz Kasa

System Code	Profile No	Weight kg/m
AWR57 F 1503	1916	1.359
Jxx cm ⁴	13.3	Jyy cm ⁴ 48.2
	A	AKB-1329-52.6

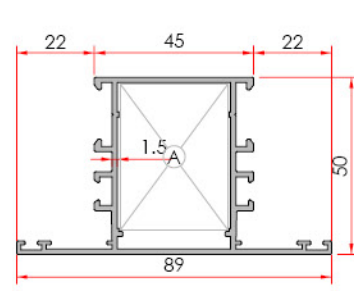

Meeting Rail
Orta Kayıt

System Code	Profile No	Weight kg/m
AW50 M 1501	1304	1.213
Jxx cm ⁴	15.2	Jyy cm ⁴ 19.5
	A	AKB-1329-41.6
	A	AOB-1323-28.6
	A	AOB-1324-30.8

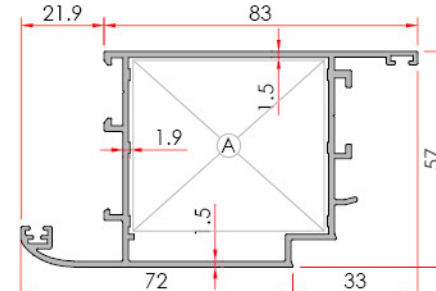

Narrow Vent
Dar Kanat

System Code	Profile No	Weight kg/m
AWR57 V 1502	1903	1.421
Jxx cm ⁴	19.4	Jyy cm ⁴ 48.2
	A	AKB-1330-46.4

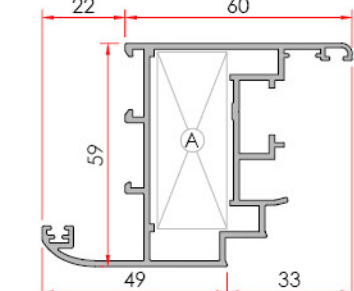

Narrow Vent
Dar Kanat

System Code	Profile No	Weight kg/m
AWR57 V 1504	1972	1.330
Jxx cm ⁴	10.6	Jyy cm ⁴ 29.3
	A	AKB-1730-47.6

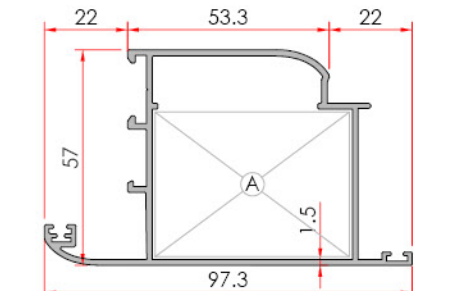

Outward Opening Vent
Dışa Açılır Kanat

System Code	Profile No	Weight kg/m
AWR57 V 1503	1904	1.295
Jxx cm ⁴	22.5	Jyy cm ⁴ 34.8
	A	AKB-1330-39.2

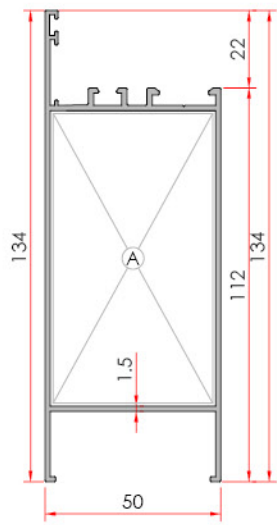

Sill Profile
Etek Profili

System Code	Profile No	Weight kg/m
AW50 K 1501	1312	1.555
Jxx cm ²	24.6	Jyy cm ² 87.4
A	AOB-1323-82.8	
A	AOB-1324-82.8	

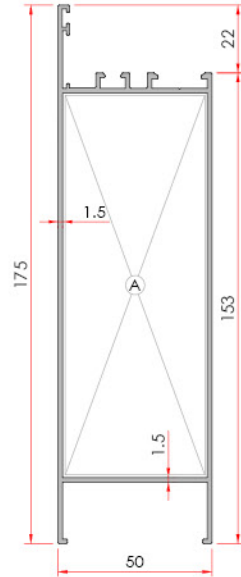

Wide Sill Profile
Geniş Etek Profili

System Code	Profile No	Weight kg/m
AW50 K 1502	1389	1.898
Jxx cm ²	32	Jyy cm ² 194
A	AOB-1323-124.6	
A	AOB-1324-124.6	

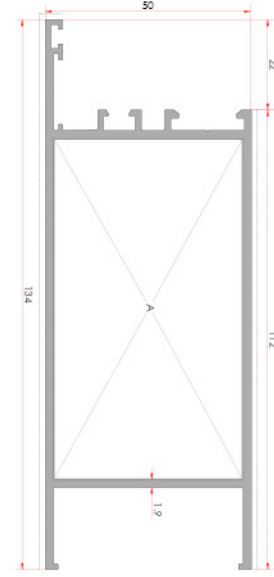

Sill Profile
Etek Profili

System Code	Profile No	Weight kg/m
AW50 K 2001	1708	2.117
Jxx cm ²	30.0	Jyy cm ² 104.6
A	AOB-1323-82.5	
A	AOB-1324-82.5	

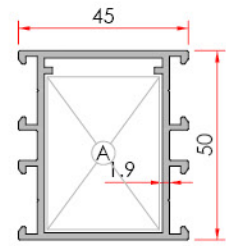

Vent
Kasa

System Code	Profile No	Weight kg/m
AW50 F 2003	1709	1.121
Jxx cm ²	13.7	Jyy cm ² 10.0
A	AKB-1329-41.6	
A	AOB-1323-28.6	
A	AOB-1324-30.8	

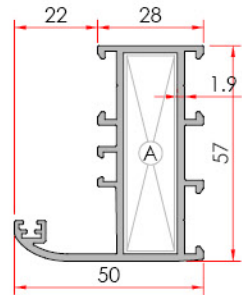

Narrow Vent
Dar Kasa

System Code	Profile No	Weight kg/m
AWR57 F 2001	1906	1.203
Jxx cm ²	18.1	Jyy cm ² 6.1
A	AKB-1328-52.6	

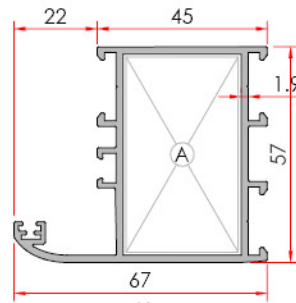

Vent
Kasa

System Code	Profile No	Weight kg/m
AWR57 F 2002	1907	1.383
Jxx cm ²	15.0	Jyy cm ² 25.2
A	AKB-1329-52.6	

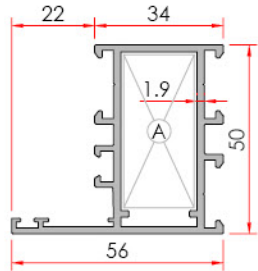

Wide Vent
Geniş Kasa

System Code	Profile No	Weight kg/m
AW50 F 2004	1790	1.100
Jxx cm ²	13.2	Jyy cm ² 4.8
A	AKB-1328-41.6	

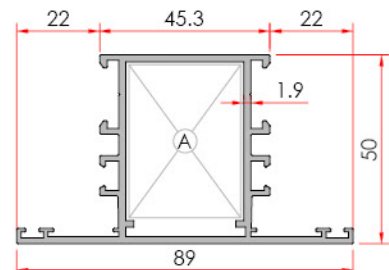

Meeting Rail
Orta Kayıt

System Code	Profile No	Weight kg/m
AW50 M 2001	1702	1.437
Jxx cm ²	18.0	Jyy cm ² 22.3
A	AKB-1329-41.6	
A	AOB-1323-28.6	
A	AOB-1324-30.8	

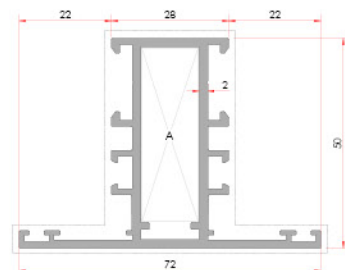

Narrow Meeting Rail
Dar Orta Kayıt

System Code	Profile No	Weight kg/m
AW50 M 2002	1703	1.373
Jxx cm ²	14.1	Jyy cm ² 9.6
A	AKB-1328-41.4	
A	AOB-1323-9.6	
A	AOB-1324-13.8	

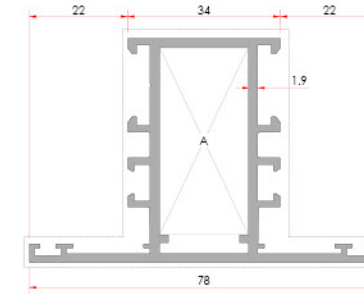

Narrow Transom
Dar Orta Kayıt

System Code	Profile No	Weight kg/m
AW50 M 2003	1789	1.448
Jxx cm ²	15.5	Jyy cm ² 13.4
A	AKB-1730-41.6	
A	AOB-1323-15.6	
A	AOB-1324-19.8	

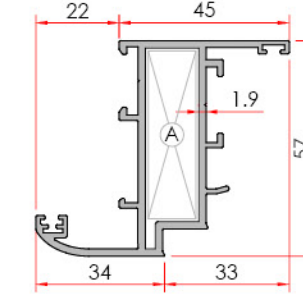

Narrow Vent
Dar Kanat

System Code	Profile No	Weight kg/m
AWR57 V 2001	1908	1.260
Jxx cm ²	22.3	Jyy cm ² 5.4
A	AKB-1328-45.6	

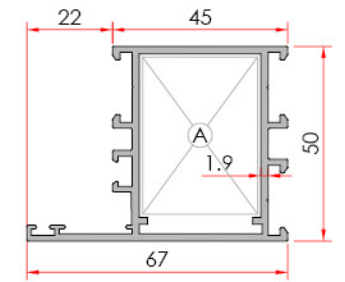

Wide Frame
Geniş Kasa

System Code	Profile No	Weight kg/m
AW50 F 2001	1700	1.277
Jxx cm ²	12.1	Jyy cm ² 19.3
A	AKB-1329-41.6	

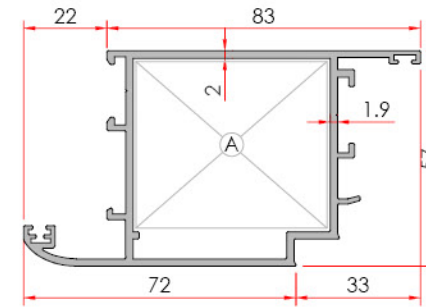

Door Vent
Kapı Kanat

System Code	Profile No	Weight kg/m
AWR57 V 2002	1909	1.693
Jxx cm ²	23.3	Jyy cm ² 54.8
A	AKB-1330-45.6	

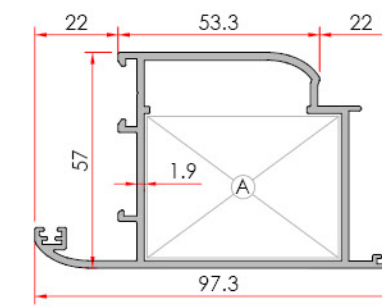

Outward Opening Vent
Dışa Açılır Kanat

System Code	Profile No	Weight kg/m
AWR57 V 2003	1910	1.563
Jxx cm ²	26.7	Jyy cm ² 39.8
A	AKB-1330-38.6	

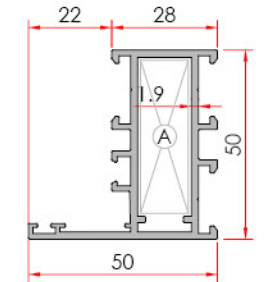

Narrow Vent
Dar Kasa

System Code	Profile No	Weight kg/m
AW50 F 2002	1701	1.100
Jxx cm ²	13.2	Jyy cm ² 4.8
A	AKB-1328-41.6	

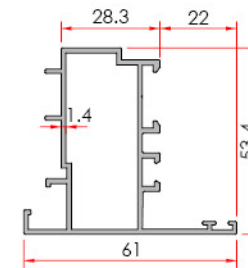

Double Vent Adapter
Çift Kanat Adaptörü

System Code	Profile No	Weight kg/m
AW50 A 01	1313	0.958

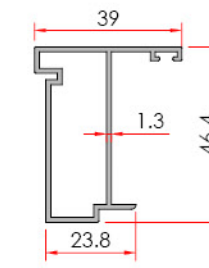

Outward Opening Middle Adapter
Dışa Açılır Orta Adaptörü

System Code	Profile No	Weight kg/m
AW50 A 02	1314	0.600

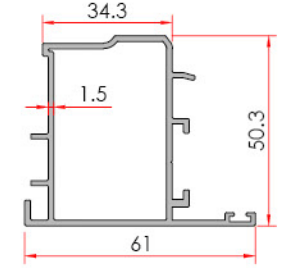

Pivoting Adapter
Pivot Adaptörü

System Code	Profile No	Weight kg/m
AW50 A 03	1380	0.940

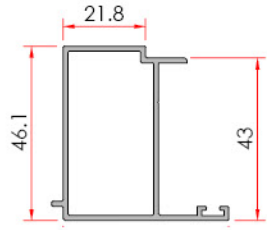

Outward Opening Adapter
Dışa Açılır Adaptör

System Code	Profile No	Weight kg/m
AW50 A 05	1383	0.633

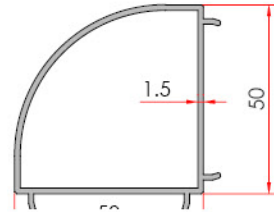

90° Corner Adapter
90° Köşe Dönüş Adaptörü

System Code	Profile No	Weight kg/m
AS50 C 01	1315	0.812

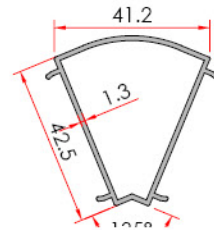

135° Corner Adapter
135° Köşe Dönüş Adaptörü

System Code	Profile No	Weight kg/m
AS50 C 02	1316	0.725

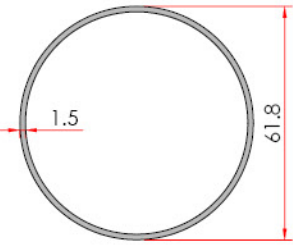

90° Circle Corner
Yuvarlak Köşe Dönüş

System Code	Profile No	Weight kg/m
AS50 C 03	1322	0.793

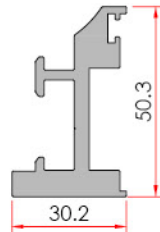

Pivoting Hinge
Pivot Menteşe

System Code	Profile No	Weight kg/m
AW50 H 01	1382	1.412

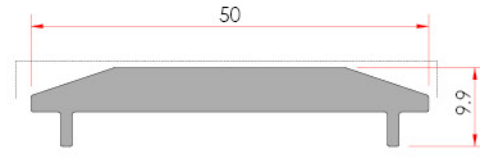

Swing Hinge Bottom
Çarpma Menteşe Altı



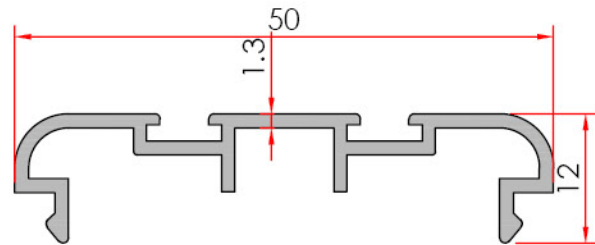

System Code	Profile No	Weight kg/m
AW50 A 04	1381	0.737

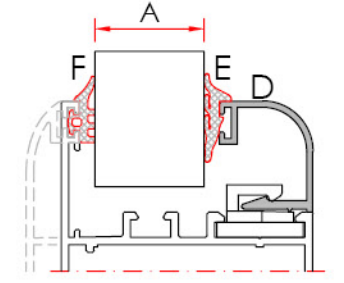
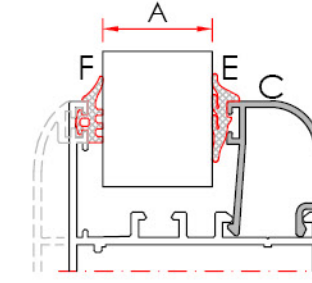
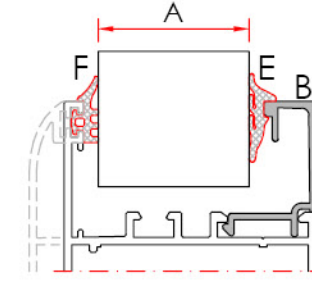

Swing Door Adapter
Çarpma Kapı Adaptörü

System Code	Profile No	Weight kg/m
AW50 A 06	1326	0.346



A	B	C	D	E			
				01-2013	01-2005	01-2023	01-2027
							
				3-3.5 mm	4-5 mm	3 mm	5.5 mm
30 mm	22 G 10			●		●	
29 mm	22 G 10				●	●	
28 mm	22 G 10				●	●	
27 mm	22 G 10			●			●
26 mm	22 G 10				●		●
25 mm	22 G 07			●		●	
24 mm	22 G 01			●		●	
23 mm	22 G 09			●		●	
22 mm	22 G 09				●	●	
21 mm	22 G 09				●	●	
21 mm		22 RG 01	22 RK 01		●	●	●
20 mm	22 G 02			●		●	
20 mm		22 RG 01	22 RK 01		●	●	●
19 mm	22 G 03			●		●	
19 mm		22 RG 02	22 RK 02	●		●	●
18 mm	22 G 03				●	●	
18 mm		22 RG 02	22 RK 02		●	●	●
17 mm	22 G 11			●		●	
17 mm		22 RG 02	22 RK 02	●		●	●
16 mm	22 G 11				●	●	
16 mm		22 RG 02	22 RK 02		●	●	●
15 mm	22 G 04			●		●	
15 mm		22 RG 02	22 RK 02		●	●	●
14 mm	22 G 08			●		●	
14 mm		22 RG 03	22 RK 03	●		●	●
13 mm	22 G 08				●	●	
13 mm		22 RG 03	22 RK 03		●	●	●
12 mm	22 G 08				●	●	
12 mm		22 RG 03	22 RK 03	●		●	●
11 mm	22 G 08			●		●	
11 mm		22 RG 03	22 RK 03		●	●	●
10 mm	22 G 05			●		●	
10 mm		22 RG 03	22 RK 03		●	●	●
9 mm	22 G 05				●	●	
8 mm	22 G 05				●	●	
7 mm	22 G 05			●		●	
6 mm	22 G 03			●		●	

DOUBLE VENT WINDOW VIEW & DETAILS - ÇİFT KANAT PENCERE GÖRÜNÜŞ VE DETAYLARI

EXTERIOR OPENING DOOR VIEW & DETAILS
DIŞA AÇILIR KAPI GÖRÜNÜŞ VE DETAYLARI

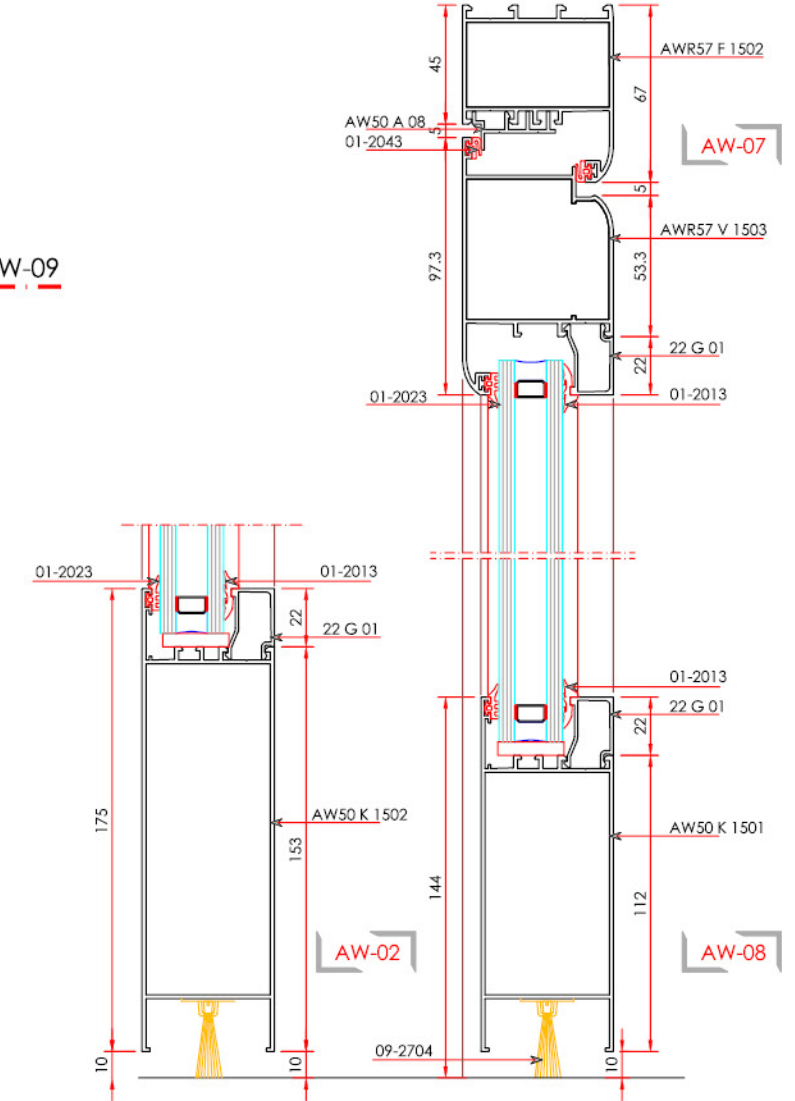
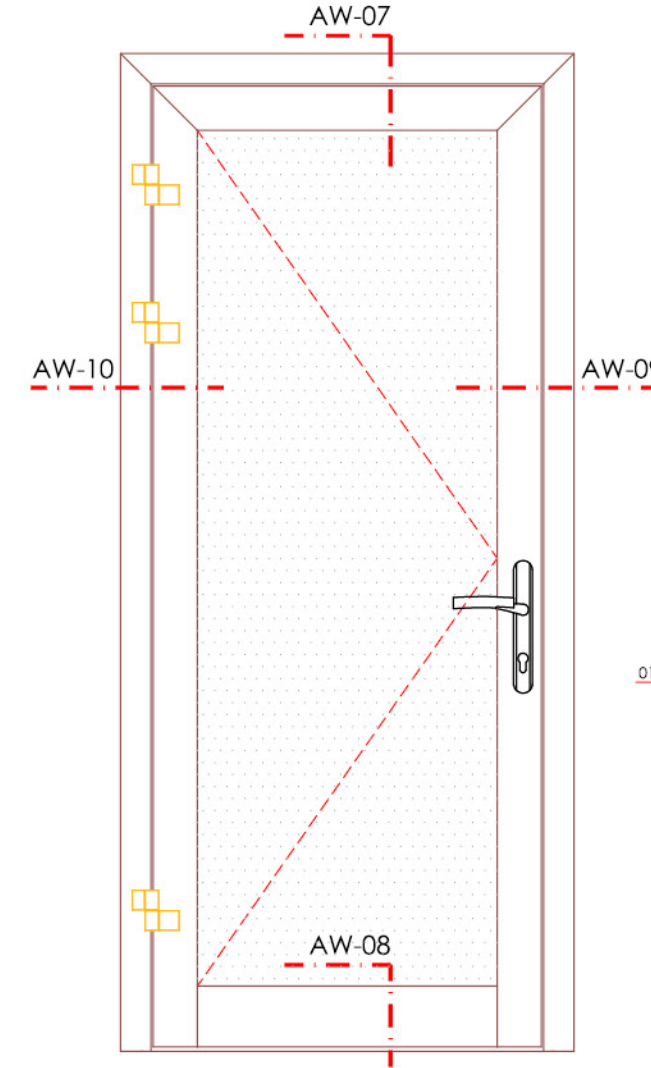
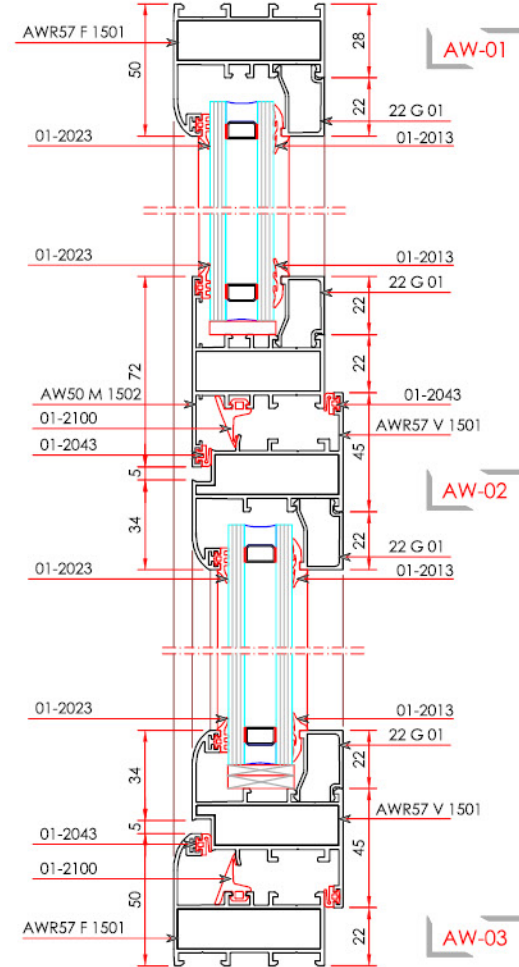
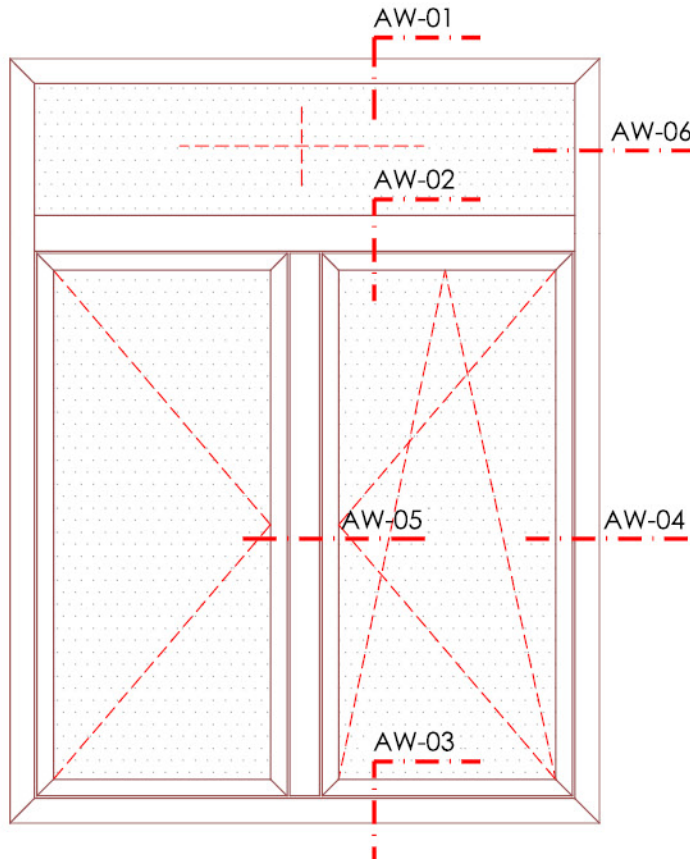

Exterior View - Dış Görünüş

Double Axisvent Dimension Çift Eksen Kanat Ölçüleri	Width / Genişlik	Height / Yükseklik
	355-1700 mm	500-2400 mm
Double Axisvent Weight Çift Eksen Kanat Ağırlığı	Max. 130 kg	
Glass Thickness Cam Kalınlığı	Max. 30 mm	

Exterior View - Dış Görünüş

Glass Thickness Cam Kalınlığı	Max. 30 mm
----------------------------------	------------

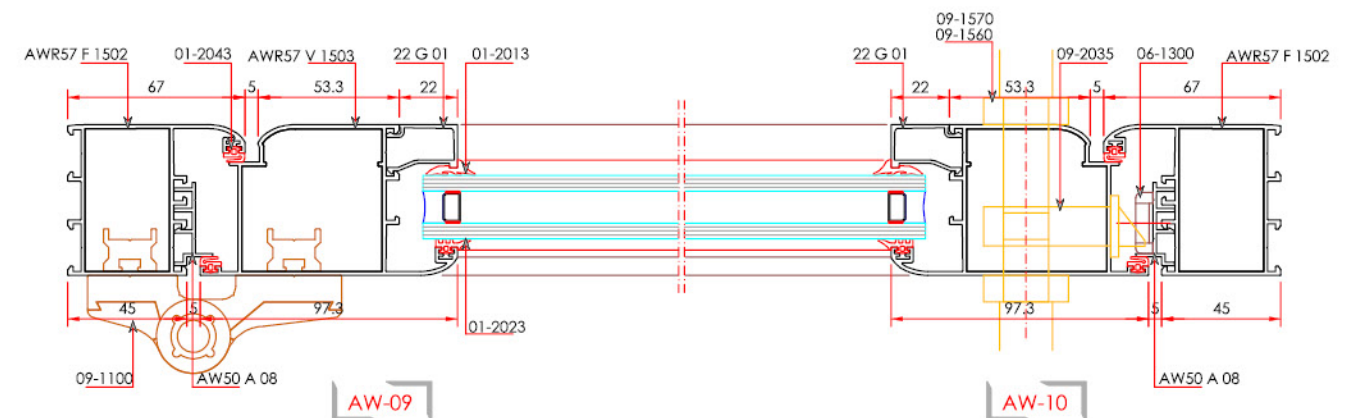
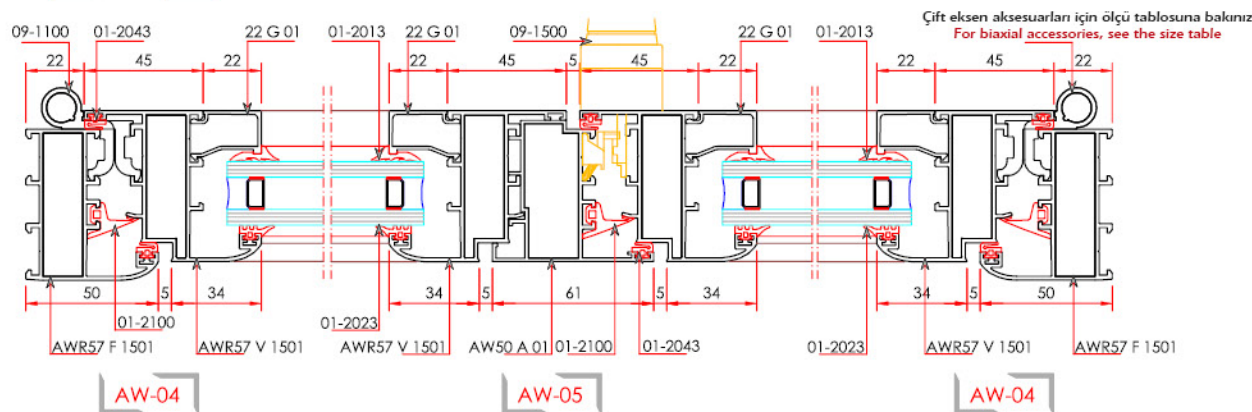
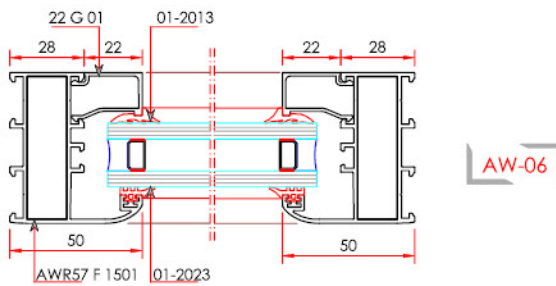

EXTERIOR OPENING DOOR VIEW & DETAILS
DIŞA AÇILIR KAPI GÖRÜNÜŞ VE DETAYLARI

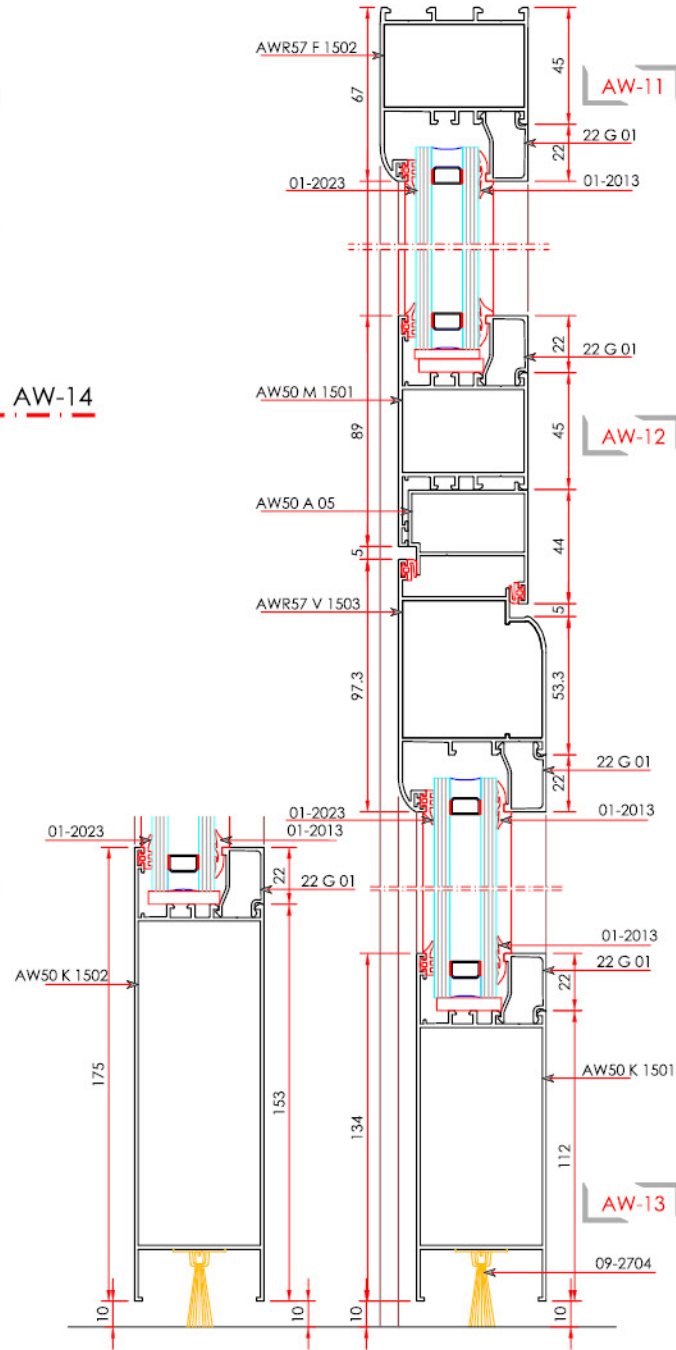
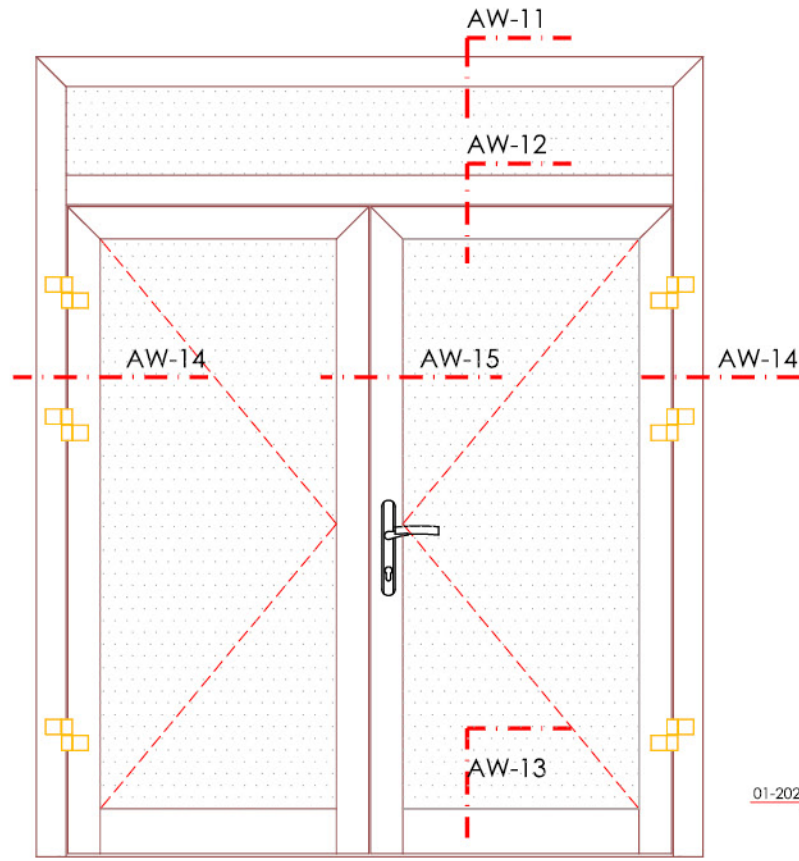

Exterior View - Dış Görünüş

Glass Thickness Cam Kalınlığı	Max. 30 mm
---	------------

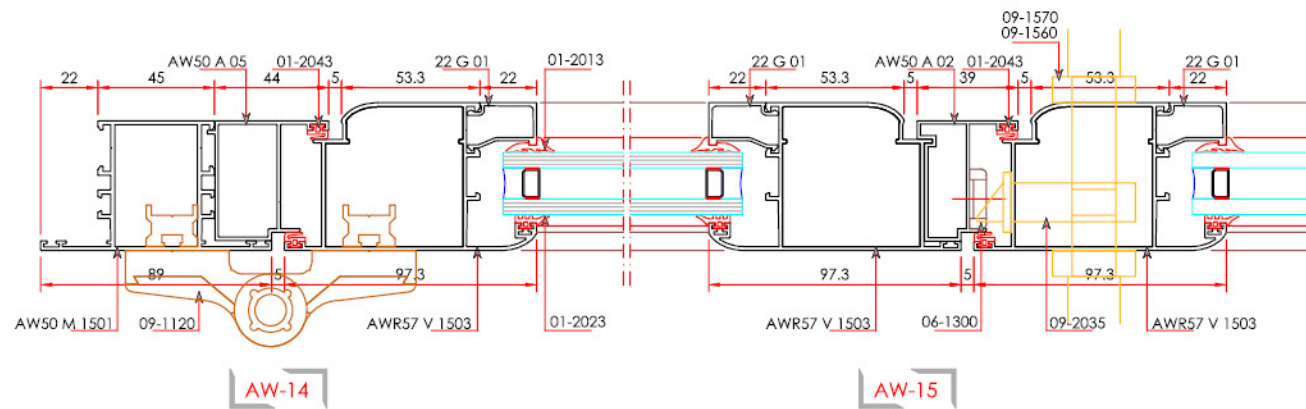

PIVOTED OPENING DOOR VIEW & DETAILS
PİVOT AÇILIM GÖRÜNÜŞ VE DETAYLARI

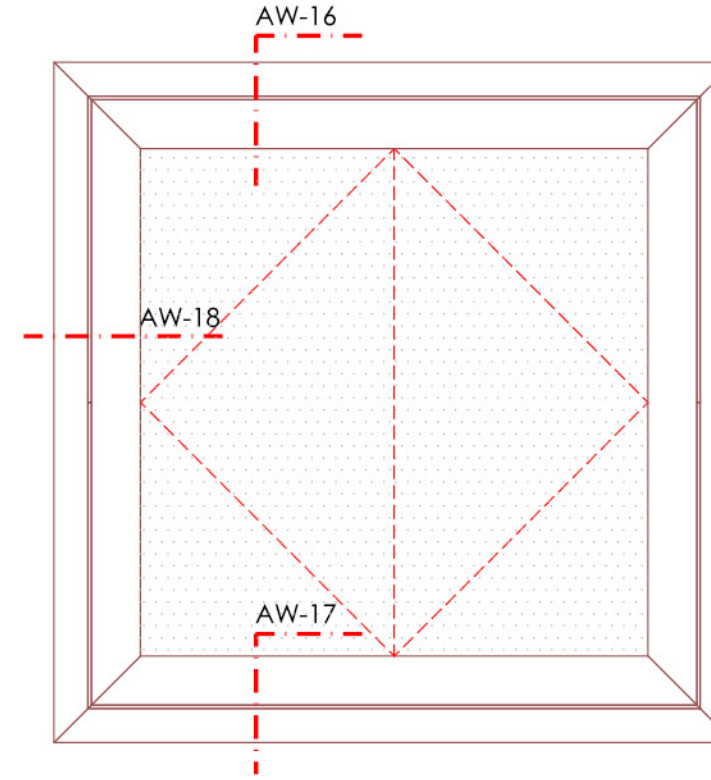

Vertical Pivoted Exterior View - Düşey Pivot Dış Görünüş

Glass Thickness Cam Kalınlığı	Max. 30 mm
---	------------

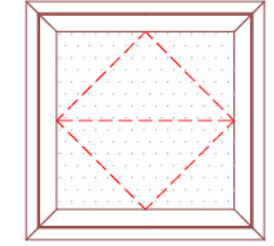
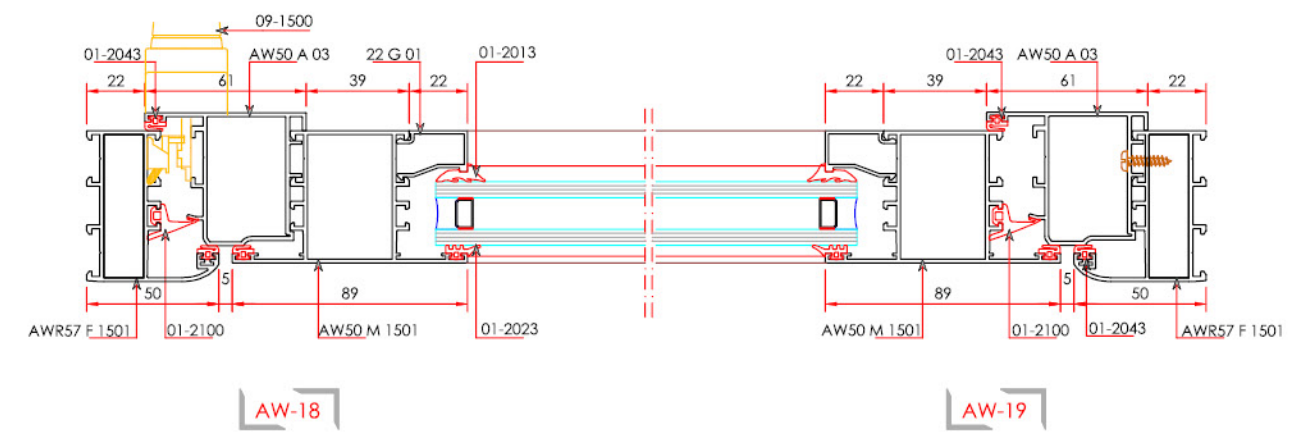

Horizontal Pivoted Exterior View
Yatay Pivot Dış Görünüş

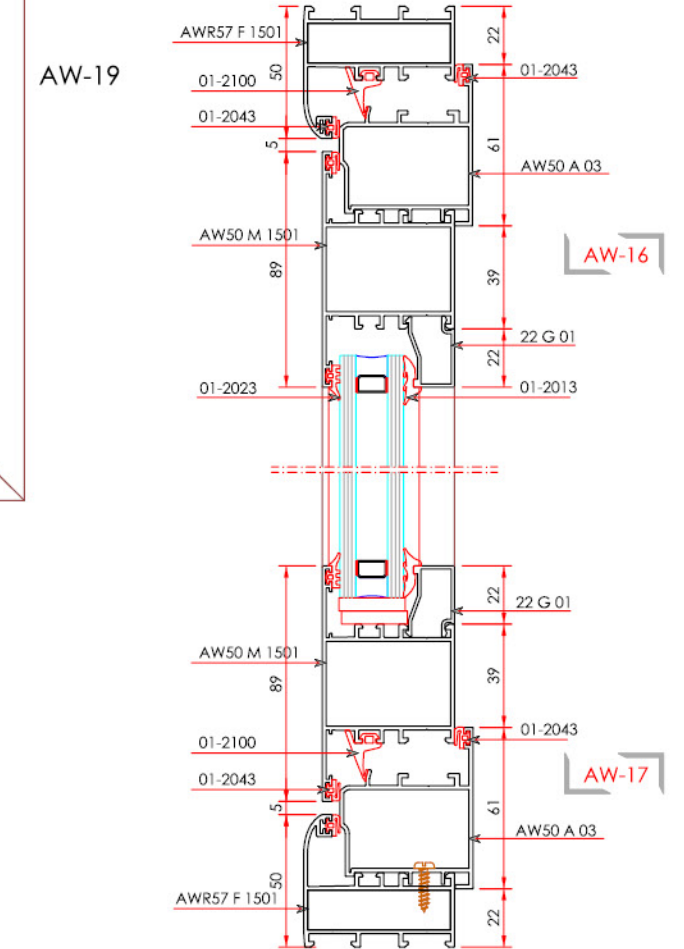

PARALLEL SLIDE & TILT VIEW & DETAILS
PARALEL ÇEK-SÜR GÖRÜNÜŞ VE DETAYLARI

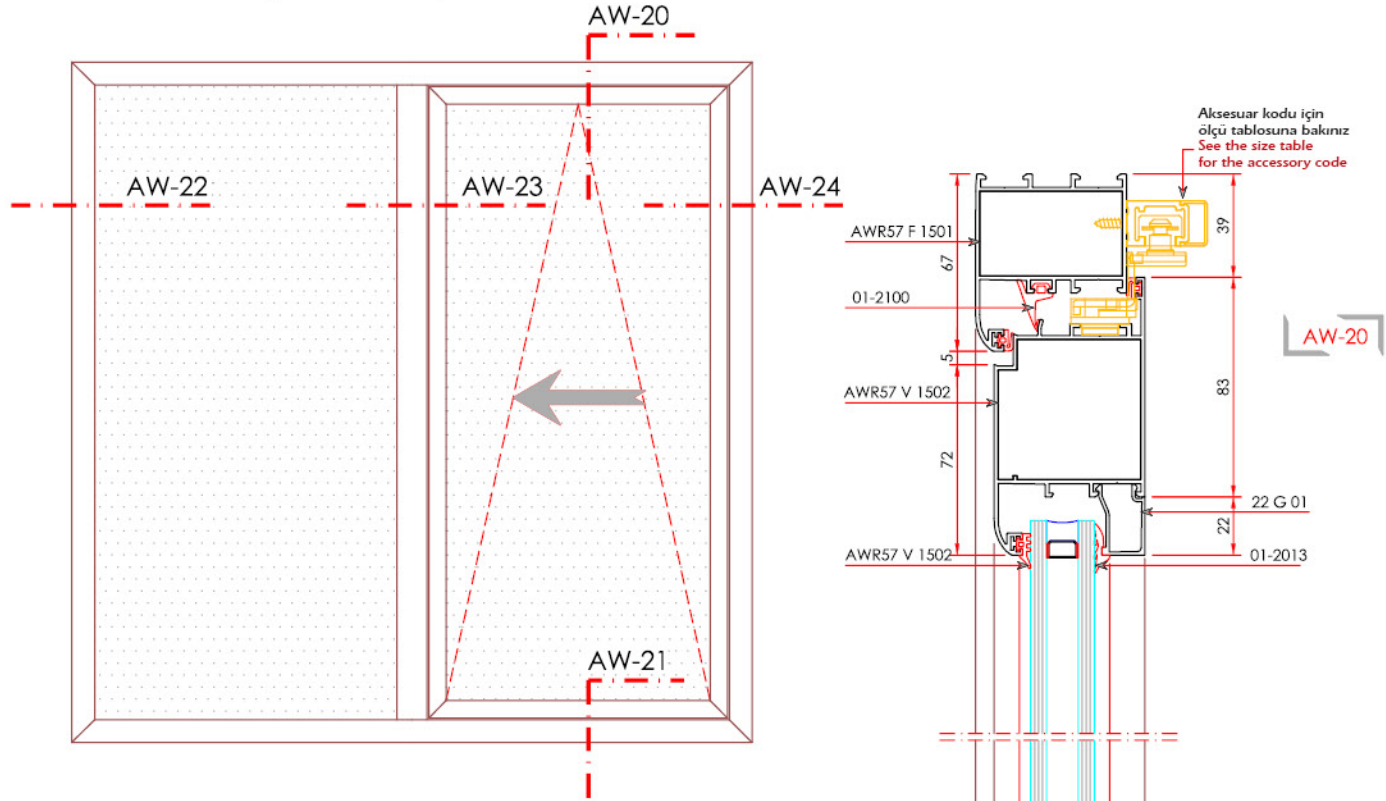

Exterior View - Dış Görünüş

Parallel Slide & Tilt Vent Dimensions Paralel Çek-Sür Kanat Ebatları 130 kg	Width - Genişlik 600-1600 mm	Height - Yükseklik 730-2400 mm
Parallel Slide & Tilt Vent Dimensions Paralel Çek-Sür Kanat Ebatları 150 kg	600-1600 mm	895-2400 mm
Parallel Slide & Tilt Vent Dimensions Paralel Çek-Sür Kanat Ebatları 200 kg	600-1600 mm	895-2400 mm

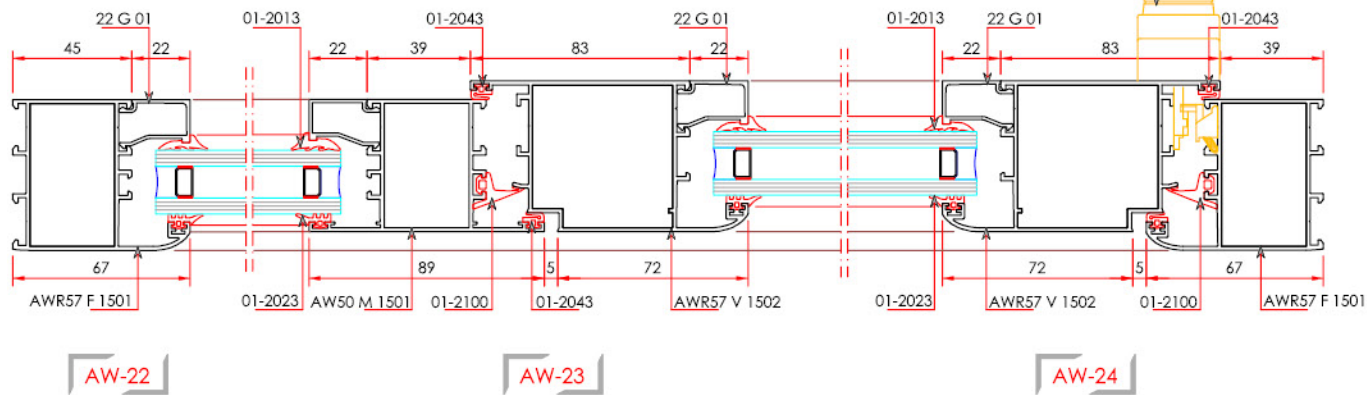

OPENING VENT VIEW & DETAILS
AÇILIR KANAT GÖRÜNÜŞ VE DETAYLARI

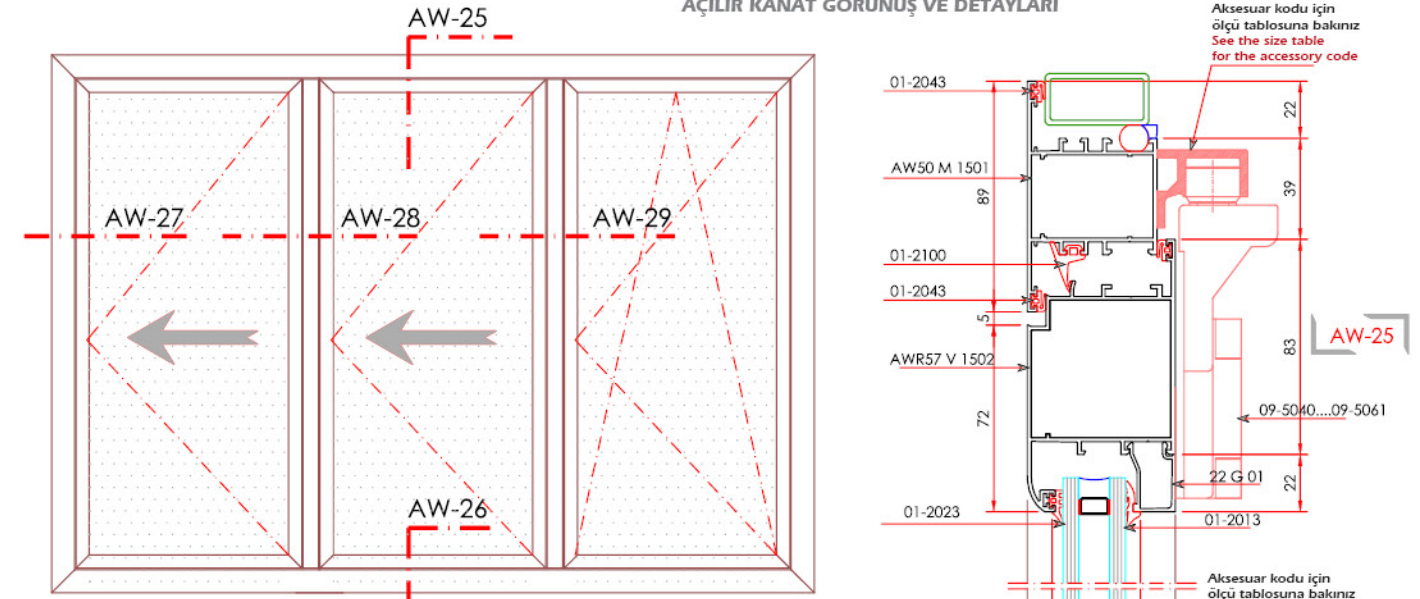

Interior View - İç Görünüş

Folding Profile Vent Dimensions Katlanır Doğrama Kanat Ebatları 80 kg	Width - Genişlik 400-1000 mm	Height - Yükseklik 850-2400 mm
--	---------------------------------	-----------------------------------

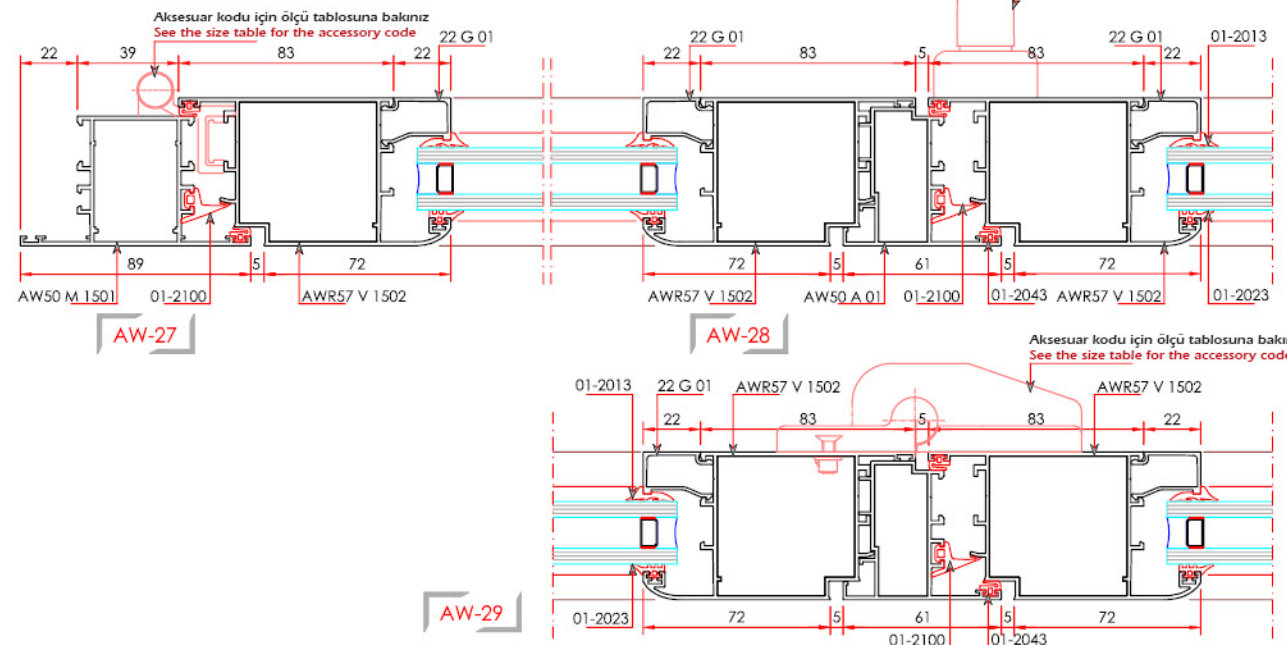
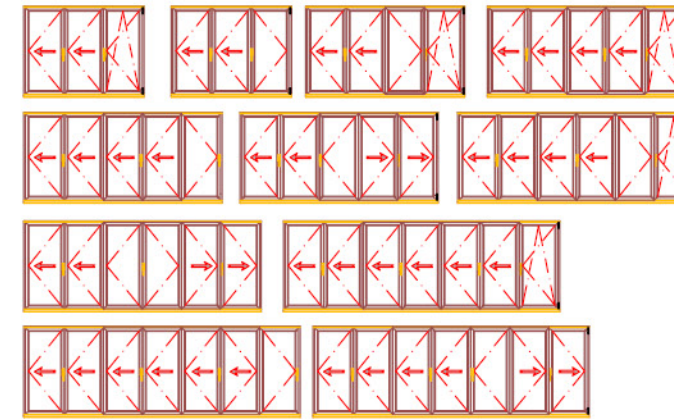



ALCAS®

ALCAS®



» GENERAL PROFILES & ACCESSORIES
GENEL PROFİLLER VE AKSESUARLAR

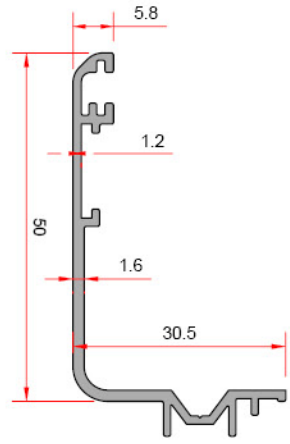

Window Sill
Pervaz Profili

System Code	Profile No	Weight kg/m
1443	1443	0.407

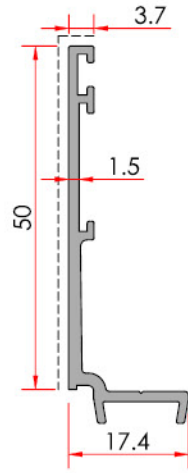

Window Sill
Pervaz Profili

System Code	Profile No	Weight kg/m
AW50 A 12	1359	0.362

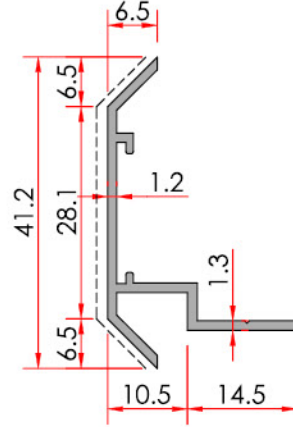

Window Sill
Pervaz Profili

System Code	Profile No	Weight kg/m
AW50 A 13	1458	0.268

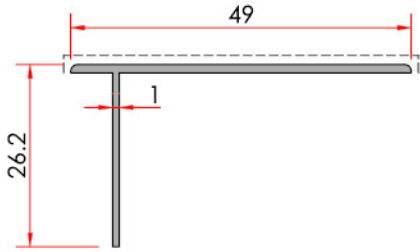

Sill Profile - T
Pervaz- T- Profili

System Code	Profile No	Weight kg/m
2815	2815	0.232

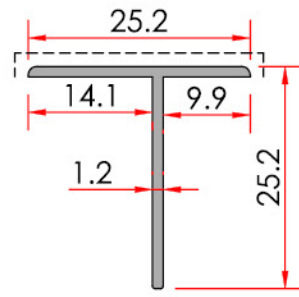

Sill Profile - T
Pervaz- T- Profili

System Code	Profile No	Weight kg/m
1874	1874	0.161

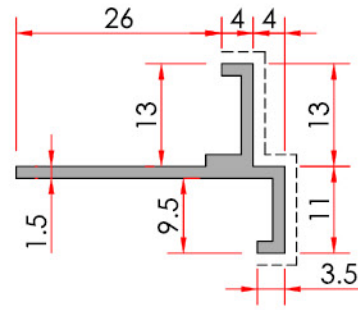

Sill Profile - T
Pervaz- T- Profili

System Code	Profile No	Weight kg/m
2147	2147	0.274

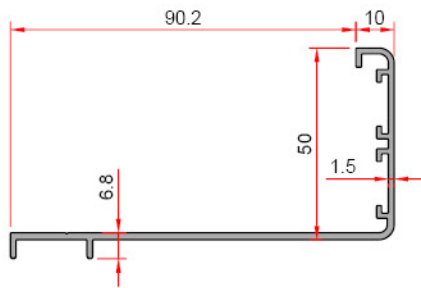

Window Sill
Pervaz Profili

System Code	Profile No	Weight kg/m
4288	4288	0.860

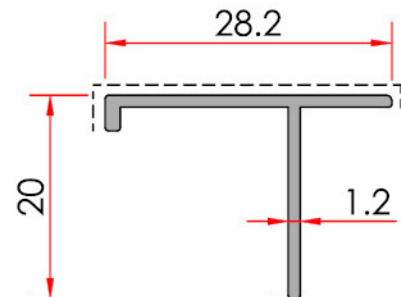

Sill Profile - T
Pervaz- T- Profili

System Code	Profile No	Weight kg/m
2844	2844	0.166

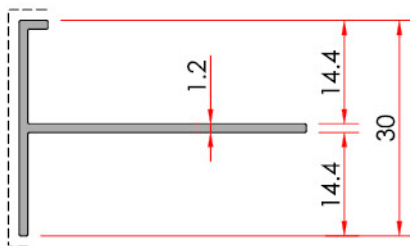

Sill Profile - T
Pervaz- T- Profili

System Code	Profile No	Weight kg/m
4284	4284	0.239

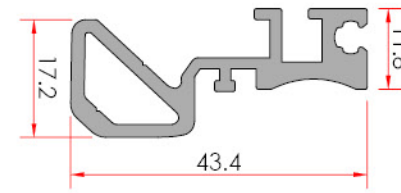

Corner Cleat
Köşe Takozu

System Code	Profile No	Weight kg/m
1905	1905	0.717

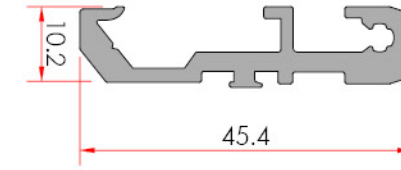

Meeting Rail Connection
Orta Kayıt Bağlantı

System Code	Profile No	Weight kg/m
1323	1323	0.613

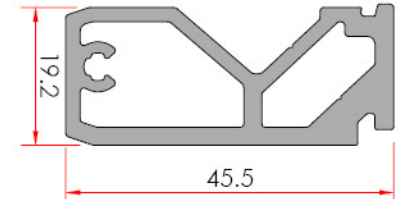

Meeting Rail Connection
Orta Kayıt Bağlantı

System Code	Profile No	Weight kg/m
1324	1324	1.011

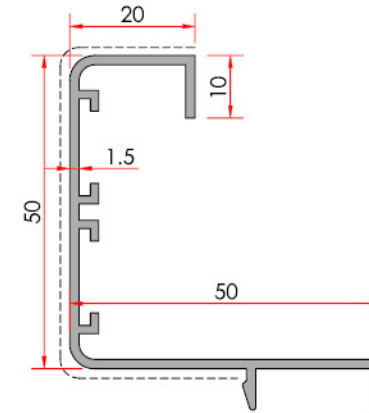

Sill Profile
Pervaz Profili

System Code	Profile No	Weight kg/m
AW50 A 11	1237	0.668

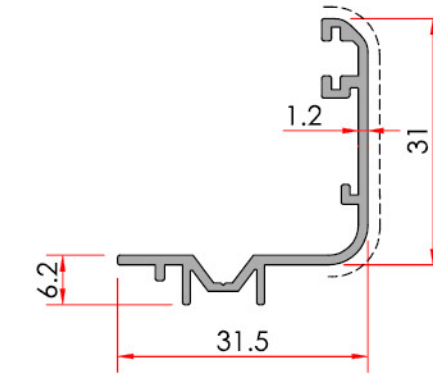

Sill Profile
Pervaz Profili

System Code	Profile No	Weight kg/m
AS50 A 06	1428	0.308

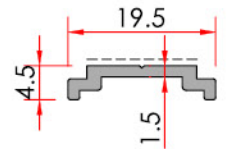

Stem
Tij

System Code	Profile No	Weight kg/m
AW50 A 10	1375	0.106

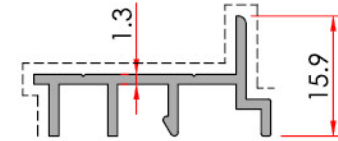

Outward Opening Fixed Adapter
Dışa Açılır Sabit Adaptör

System Code	Profile No	Weight kg/m
AW50 A 08	1317	0.241

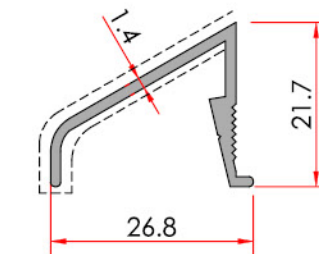

Drainage
Damlalık

System Code	Profile No	Weight kg/m
AW50 A 09	1321	0.234

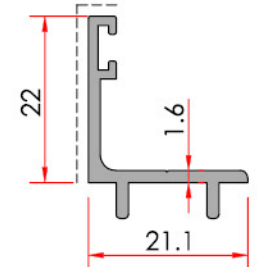

Corner Cleat
İlave Kulak

System Code	Profile No	Weight kg/m
AWD 60 A 05	1610	0.244

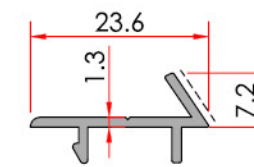

Corner Cleat
İlave Kulak

System Code	Profile No	Weight kg/m
AS50 A 01	1318	0.143

Bead - Çıta
System Code
22 G 03
Profile No 1368
Weight kg/m 0.285

Bead - Çıta
System Code
22 G 02
Profile No 1366
Weight kg/m 0.278

Bead - Çıta
System Code
22 G 06
Profile No 1371
Weight kg/m 0.343

Bead - Çıta
System Code
22 RK 03
Profile No 2923
Weight kg/m 0.247

Bead - Çıta
System Code
22 RK 02
Profile No 1959
Weight kg/m 0.228

Bead - Çıta
System Code
22 G 09
Profile No 1613
Weight kg/m 0.268

Bead - Çıta
System Code
22 G 05
Profile No 1370
Weight kg/m 0.328

Bead - Çıta
System Code
22 RK 01
Profile No 1958
Weight kg/m 0.220

Bead - Çıta
System Code
22 G 01
Profile No 1367
Weight kg/m 0.265

Bead - Çıta
System Code
22 G 08
Profile No 1612
Weight kg/m 0.309

Bead - Çıta
System Code
22 RG 03
Profile No 2924
Weight kg/m 0.287

Bead - Çıta
System Code
22 G 07
Profile No 1611
Weight kg/m 0.260

Bead - Çıta
System Code
22 G 04
Profile No 1369
Weight kg/m 0.300

Bead - Çıta
System Code
22 RG 02
Profile No 1957
Weight kg/m 0.264

Bead - Çıta
System Code
22 G 10
Profile No 1378
Weight kg/m 0.228

Bead - Çıta
System Code
22 G 11
Profile No 1616
Weight kg/m 0.291

Bead - Çıta
System Code
22 RG 01
Profile No 1956
Weight kg/m 0.257

**Corner Cleat
Köşe Takozu**

Profile No	Weight kg/m
1328	4.255

Aksesuar Kodu	Profil Kodu
AKB-1328-37	AW40 F 1201 (2772)
	AW40 F 1202 (1791)
	AW40 M 1201 (2773)
	AW40 F 1201 (2771)

**Corner Cleat
Köşe Takozu**

Profile No	Weight kg/m
1963	5.752

Aksesuar Kodu	Profil Kodu
AKB-1963-37	AW40 V 1202 (1740)

**Meeting Rail Connection
Orta Kayıt Bağlantı**

Profile No	Weight kg/m
1625	1.194

Aksesuar Kodu	Profil Kodu
AOB-1625-13.8	AW40 M 1201 (2773)

**Corner Cleat
Köşe Takozu**

System Code	Profile No	Weight kg/m
1329	1329	4.388

**Corner Cleat
Köşe Takozu**

System Code	Profile No	Weight kg/m
1327	1327	12.021

**Corner Cleat
Köşe Takozu**

System Code	Profile No	Weight kg/m
1618	1618	5.853

**Corner Cleat
Köşe Takozu**









System Code	Profile No	Weight kg/m
1330	1330	8.130

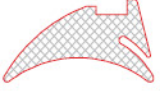

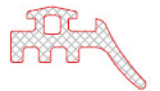
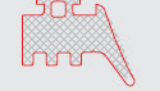



**Corner Cleat
Köşe Takozu**



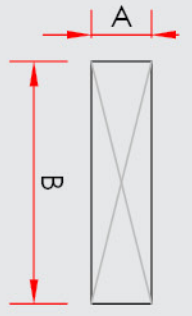
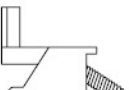

System Code	Profile No	Weight kg/m
1730	1730	5.210

**Corner Cleat
Köşe Takozu**

System Code	Profile No	Weight kg/m
1619	1619	5.912



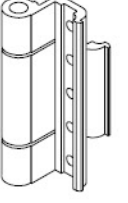
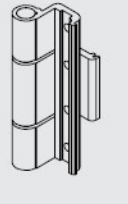

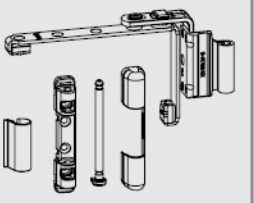
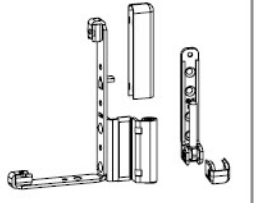
CODE / KOD	ACCESSORIES / AKSESUAR	DESCRIPTION / AÇIKLAMA
01-2005		5 mm Gasket 5 mm Conta 235 mt / Koli
01-2013		3 mm Gasket 3 mm Conta 300 mt / Koli
01-2023		3 mm Gasket 3 mm Conta 375 mt / Koli
01-2027		5.5 mm Gasket 5.5 mm Conta 230 mt / Koli
01-2033		3 mm Gasket 3 mm Bini Conta 375 mt / Koli
01-2043		3 mm Gasket 3 mm Bini Conta 325 mt / Koli
01-2100		Gasket Orta Yalıtım Fitali 125-132 mt/Koli
03-2003		Volcanised Gasket Köşe Kaynaklı Fital Pieces / Adet
03-2006		Drainage Caps Tahliye Kapağı Pieces / Adet

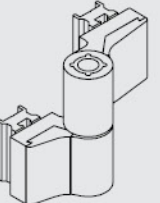
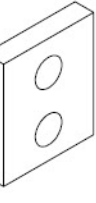
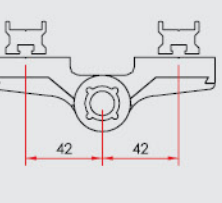
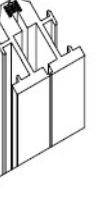
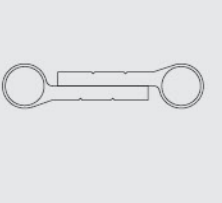
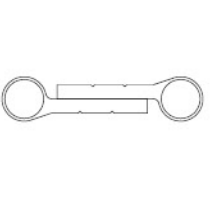
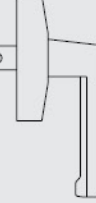
CODE / KOD	ACCESSORIES / AKSESUAR	DESCRIPTION / AÇIKLAMA																								
03-2007		Glazing Bead Clips Cam Çıtası Klipsi Package / Paket 50 Pieces / Adet																								
03-2010 03-2011 03-2012		Plastic Plug 12 mm Montaj Tapası 12 mm 03-2010 White / Beyaz 03-2011 Gray / Gri 03-2012 Brown / Kahverengi																								
03-2082 03-2084 03-2002 03-2203 03-2205 03-2252 03-2253 02-2255 02-2282 02-2283 02-2285	<table border="1"> <thead> <tr> <th>A</th> <th>B</th> </tr> </thead> <tbody> <tr><td>2</td><td>8</td></tr> <tr><td>4</td><td>8</td></tr> <tr><td>2</td><td>20</td></tr> <tr><td>3</td><td>20</td></tr> <tr><td>5</td><td>20</td></tr> <tr><td>2</td><td>25</td></tr> <tr><td>3</td><td>25</td></tr> <tr><td>5</td><td>25</td></tr> <tr><td>2</td><td>28</td></tr> <tr><td>3</td><td>28</td></tr> <tr><td>5</td><td>28</td></tr> </tbody> </table> 	A	B	2	8	4	8	2	20	3	20	5	20	2	25	3	25	5	25	2	28	3	28	5	28	PVC Glazing Cleat Plastik Cam Takozu
A	B																									
2	8																									
4	8																									
2	20																									
3	20																									
5	20																									
2	25																									
3	25																									
5	25																									
2	28																									
3	28																									
5	28																									
05-1003		Part Locking Ayarlı İspanyolet Karşılığı Pieces / Adet																								
06-1300		Locking Plate Makaralı Kilit Karşılığı Pieces / Adet																								
06-1301		Locking Plate Makaralı Kilit Karşılığı Pieces / Adet																								
06-1302		Handle Locking Dilli Kilit Karşılığı Pieces / Adet																								

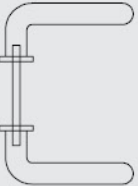
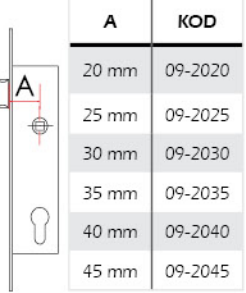
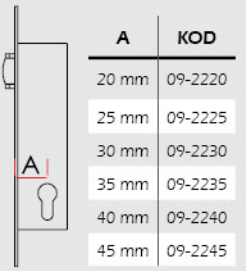
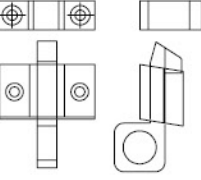
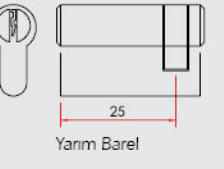
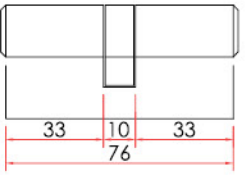

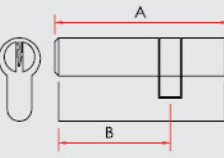
CODE / KOD	ACCESSORIES / AKSESUAR	DESCRIPTION / AÇIKLAMA
06-1303		Handle Locking Makaralı Kilit Karşılığı Pieces / Adet
06-1304		Fixing Locking Kilit Karşılığı Pieces / Adet
09-1010 09-1011 09-1012 09-1013 09-1014		Hinge For Aluminium Canal Pencere Menteşesi (Alüminyum kanal için) 09-1010 Anodized / Eloksal 09-1011 White / Beyaz 09-1120 Brown / Kahverengi 09-1013 Raw / Ham 09-1014 Special / Özel Renk
09-1020 09-1021 09-1022 09-1023 09-1024		Hinge For PVC Canal Pencere Menteşesi (PVC kanal için) 09-1020 Anodized / Eloksal 09-1021 White / Beyaz 09-1022 Brown / Kahverengi 09-1023 Raw / Ham 09-1024 Special / Özel Renk
09-1030 09-1031 09-1032 09-1033		Stell Middle Hinge For Pvc Canal Çelik Orta Menteşe (PVC kanal için) 09-1030 Gray / Gri 09-1031 White / Beyaz 09-1032 Brown / Kahverengi
09-1035 09-1036 09-1037		Stell Top Hinge For Pvc Canal PVC Kanal İçin Çelik Üst Menteşe 09-1035 Gray / Gri 09-1036 White / Beyaz 09-1037 Brown / Kahverengi
09-1040 09-1041 09-1042		Stell Bottom Hinge For Pvc Canal PVC Kanal İçin Çelik Alt Menteşe 09-1040 Gray / Gri 09-1041 White / Beyaz 09-1042 Brown / Kahverengi

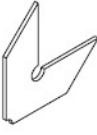
CODE / KOD	ACCESSORIES / AKSESUAR	DESCRIPTION / AÇIKLAMA
09-1100 09-1101 09-1102 09-1103 09-1104		Door Hinges Kapı Menteşesi 09-1010 Anodized / Eloksal 09-1101 White / Beyaz 09-1102 Brown / Kahverengi 09-1103 Raw / Ham 09-1104 Special / Özel Renk
09-1110 09-1111 09-1112 09-1113 09-1114		Door Hinge Plate Kapı Menteşesi Beslemesi 09-1110 Anodized / Eloksal 09-1111 White / Beyaz 09-1112 Brown / Kahverengi 09-1113 Raw / Ham 09-1114 Special / Özel Renk
09-1120 09-1121 09-1122 09-1123 09-1124		Door Hinges Kapı Menteşesi 09-1120 Anodized / Eloksal 09-1121 White / Beyaz 09-1122 Brown / Kahverengi 09-1123 Raw / Ham 09-1124 Special / Özel Renk
09-1140 09-1141 09-1142 09-1143 09-1144		Hinge Pivot For AW55-AWR57 AW55-AWR57 Pivot Menteşe Anodized / Eloksal White / Beyaz Brown / Kahverengi Raw / Ham Special / Özel Renk
09-1150 09-1151 09-1152 09-1153 09-1154		33 Nr. Alu. Door Hinge 33 Nr. Alüminyum Çarpma Kapı Menteşe Anodized / Eloksal White / Beyaz Brown / Kahverengi Raw / Ham Special / Özel Renk
09-1160 09-1161 09-1162 09-1163 09-1164		36 Nr. Alu. Door Hinge 36 Nr. Alüminyum Çarpma Kapı Menteşe Anodized / Eloksal White / Beyaz Brown / Kahverengi Raw / Ham Special / Özel Renk
09-1500 09-1501 09-1502 09-1503 09-1504		Window Handle (Cremone) Eksantrik İspanyolet Kolu 09-1500 Anodized / Eloksal 09-1501 White / Beyaz 09-1502 Brown / Kahverengi 09-1503 Raw / Ham 09-2704 Special / Özel Renk

CODE / KOD	ACCESSORIES / AKSESUAR	DESCRIPTION / AÇIKLAMA														
09-1520 09-1521 09-1522 09-1523 09-1524		Window Handle Pencere Kolu 09-1520 Anodized / Eloksoal 09-1521 White / Beyaz 09-1522 Brown / Kahverengi 09-1523 Raw / Ham 09-1524 Special / Özel Renk														
09-1560 09-1561 09-1562 09-1563 09-1564		Door Handle Kapı Kolu 09-1560 Anodized / Eloksoal 09-1561 White / Beyaz 09-1562 Brown / Kahverengi 09-1563 Raw / Ham 09-1564 Special / Özel Renk														
09-2020 09-2025 09-2030 09-2035 09-2040 09-2045	 <table border="1"> <thead> <tr> <th>A</th> <th>KOD</th> </tr> </thead> <tbody> <tr> <td>20 mm</td> <td>09-2020</td> </tr> <tr> <td>25 mm</td> <td>09-2025</td> </tr> <tr> <td>30 mm</td> <td>09-2030</td> </tr> <tr> <td>35 mm</td> <td>09-2035</td> </tr> <tr> <td>40 mm</td> <td>09-2040</td> </tr> <tr> <td>45 mm</td> <td>09-2045</td> </tr> </tbody> </table>	A	KOD	20 mm	09-2020	25 mm	09-2025	30 mm	09-2030	35 mm	09-2035	40 mm	09-2040	45 mm	09-2045	Lack With Latch Dilli Kilit Pieces / Adet
A	KOD															
20 mm	09-2020															
25 mm	09-2025															
30 mm	09-2030															
35 mm	09-2035															
40 mm	09-2040															
45 mm	09-2045															
09-2220 09-2225 09-2230 09-2235 09-2240 09-2245	 <table border="1"> <thead> <tr> <th>A</th> <th>KOD</th> </tr> </thead> <tbody> <tr> <td>20 mm</td> <td>09-2220</td> </tr> <tr> <td>25 mm</td> <td>09-2225</td> </tr> <tr> <td>30 mm</td> <td>09-2230</td> </tr> <tr> <td>35 mm</td> <td>09-2235</td> </tr> <tr> <td>40 mm</td> <td>09-2240</td> </tr> <tr> <td>45 mm</td> <td>09-2245</td> </tr> </tbody> </table>	A	KOD	20 mm	09-2220	25 mm	09-2225	30 mm	09-2230	35 mm	09-2235	40 mm	09-2240	45 mm	09-2245	Lock With Roller Makaralı Dilli Kilit Pieces / Adet
A	KOD															
20 mm	09-2220															
25 mm	09-2225															
30 mm	09-2230															
35 mm	09-2235															
40 mm	09-2240															
45 mm	09-2245															
09-2400		Spring Catch Çarpma Kilit Pieces / Adet														
09-2540	 <p>25 Yarım Barel</p>	Lock Half Cylinder Yarım Barel Pieces / Adet														
09-2576	 <p>33 10 33 76</p>	AWD60 Symmetrical Barel Simetrik Barel Pieces / Adet														

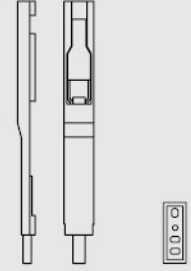
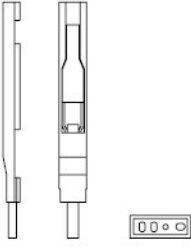
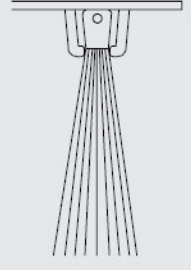
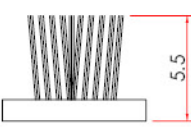
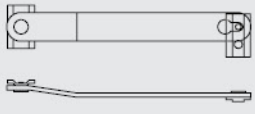
CODE / KOD	ACCESSORIES / AKSESUAR	DESCRIPTION / AÇIKLAMA												
09-2575 09-2585 09-2590	 <table border="1"> <thead> <tr> <th>KOD</th> <th>A</th> <th>B</th> </tr> </thead> <tbody> <tr> <td>09-2575</td> <td>75 mm</td> <td>40 mm</td> </tr> <tr> <td>09-2585</td> <td>85 mm</td> <td>50 mm</td> </tr> <tr> <td>09-2590</td> <td>90 mm</td> <td>55 mm</td> </tr> </tbody> </table>	KOD	A	B	09-2575	75 mm	40 mm	09-2585	85 mm	50 mm	09-2590	90 mm	55 mm	Lock Cylinder Asimetrik Barel Pieces / Adet
KOD	A	B												
09-2575	75 mm	40 mm												
09-2585	85 mm	50 mm												
09-2590	90 mm	55 mm												
09-2604		4.8 mm Alignment Corner 4.8 mm Köşe Gönye Pieces / Adet												
09-2609		9.3 mm alignment corner 9.3 mm Köşe Gönye Pieces / Adet												
09-2615		18.2 mm Alignment Corner 18.2 mm Köşe Gönye Pieces / Adet												
09-2618		18.2 mm Alignment Corner 18.2 mm Köşe Gönye Pieces / Adet												
09-2700		Locking port İspanyolet Pimi Seti Pieces / Adet												

CODE / KOD	ACCESSORIES / AKSESUAR	DESCRIPTION / AÇIKLAMA
09-2702		Supporting Latch Çift Kanat Sürgü Pieces / Adet
09-2703		Supporting Latch (Short) Çift Kanat Sürgü (Kısa) Pieces / Adet
09-2704		Strip Brush Kapı Altı Firçası Pieces / Adet
09-2855	 <p>5.5</p>	5.5 Gasket 5.5 Kıl Fıtlı Meter / Metre
09-3100		Aluminium Awning Window Arm Vasistas Makas - Alüminyum Pieces / Adet

CODE / KOD	ACCESSORIES / AKSESUAR	DESCRIPTION / AÇIKLAMA																				
09-3101		Stainless Awning Window Arm Vasistas Makas - Paslanmaz Pieces / Adet																				
09-5073 09-5074 09-5075 09-5076 09-5077 09-5078 09-5079 09-5080 09-5081	 <table border="1"> <thead> <tr> <th>L</th> <th>CODE / KODE</th> </tr> </thead> <tbody> <tr> <td>400</td> <td>09-5073</td> </tr> <tr> <td>600</td> <td>09-5074</td> </tr> <tr> <td>800</td> <td>09-5075</td> </tr> <tr> <td>1000</td> <td>09-5076</td> </tr> <tr> <td>1200</td> <td>09-5077</td> </tr> <tr> <td>1400</td> <td>09-5078</td> </tr> <tr> <td>1600</td> <td>09-5079</td> </tr> <tr> <td>1800</td> <td>09-5080</td> </tr> <tr> <td>2000</td> <td>09-5081</td> </tr> </tbody> </table>	L	CODE / KODE	400	09-5073	600	09-5074	800	09-5075	1000	09-5076	1200	09-5077	1400	09-5078	1600	09-5079	1800	09-5080	2000	09-5081	
L	CODE / KODE																					
400	09-5073																					
600	09-5074																					
800	09-5075																					
1000	09-5076																					
1200	09-5077																					
1400	09-5078																					
1600	09-5079																					
1800	09-5080																					
2000	09-5081																					

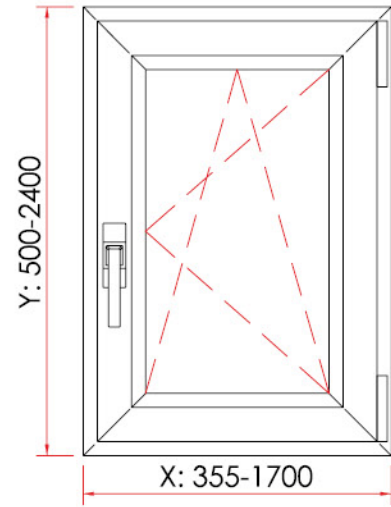

ALUMINIUM DOUBLE OPENING MECHANISM ALÜMİNYUM ÇİFT AÇILIM MEKANİZMASI					
SIZE / ÖLÇÜLER	WIDTH / GENİŞLİK				
HEIGHT / YÜKSEKLİK	410-700	701-1000	1001-1200	1201-1350	1351-1700
500 - 1200	09-5000	09-5001	09-5002	09-5003	09-5004
1201 - 2400	09-5005	09-5006	09-5007	09-5008	09-5009



TILT-TURN WINDOWS FOR PVC / PVC ÇİFT AÇILIM MEKANİZMASI						
SIZE / ÖLÇÜLER	WIDTH / GENİŞLİK					
HEIGHT / YÜKSEKLİK	401-500	501-750	751-950	951-1200	1201-1450	1451-1600
450 - 590	09-5100	09-5101	09-5102	09-5103	09-5104	09-5105
591 - 750	09-5106	09-5107	09-5108	09-5109	09-5110	09-5111
751-1200	09-5112	09-5113	09-5114	09-5115	09-5116	09-5117
1201-1450	09-5118	09-5119	09-5120	09-5121	09-5122	09-5123
1451-1950	09-5124	09-5125	09-5126	09-5127	09-5128	09-5129
1951-2450	09-5130	09-5131	09-5132	09-5133	09-5134	09-5135

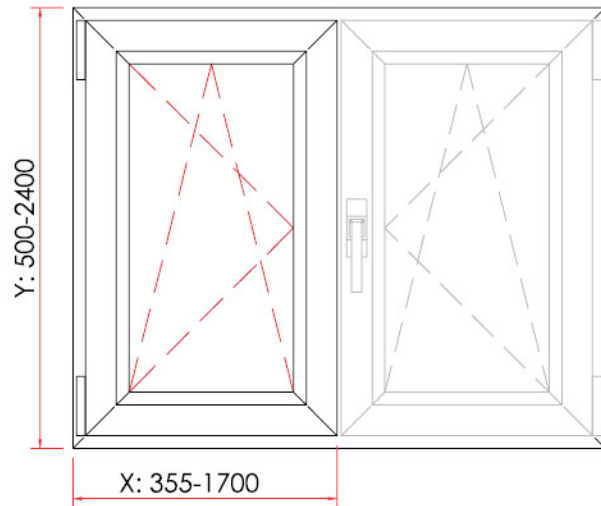

TILT-TURN WINDOWS FOR ALUMINIUM ALÜMİNYUM ÇİFT KANAT ÇİFT AÇILIM MEKANİZMASI					
SIZE / ÖLÇÜLER	WIDTH / GENİŞLİK				
HEIGHT / YÜKSEKLİK	410-700	701-1000	1001-1200	1201-1350	1351-1700
500-1200	09-5250	09-5251	09-5252	09-5253	09-5254
1201-2400	09-5255	09-5256	09-5257	09-5258	09-5259

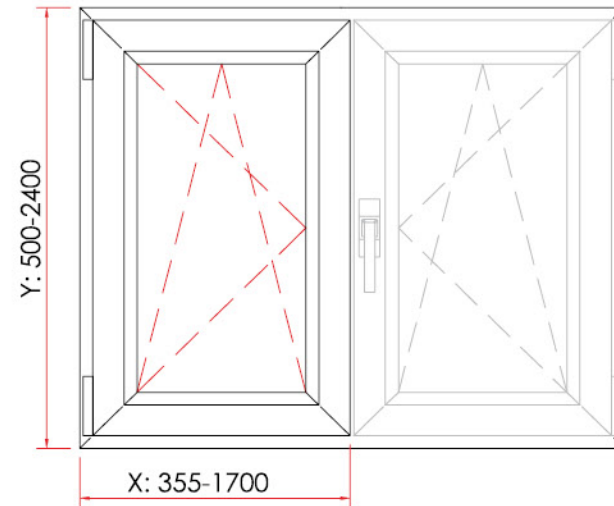

TILT-TURN WINDOWS FOR PVC PVC ÇİFT KANAT ÇİFT AÇILIM MEKANİZMASI				
SIZE / ÖLÇÜLER	WIDTH / GENİŞLİK			
HEIGHT / YÜKSEKLİK	280-750	751-950	951-1200	1201-1600
470-720	09-5140	09-5141	09-5142	09-5143
721-850	09-5144	09-5145	09-5146	09-5147
851-1100	09-5148	09-5149	09-5150	09-5151
1101-1350	09-5152	09-5153	09-5154	09-5155
1351-1600	09-5156	09-5157	09-5158	09-5159
1601-1850	09-5160	09-5161	09-5162	09-5163
1851-2100	09-5164	09-5165	09-5166	09-5167
2101-2350	09-5168	09-5169	09-5170	09-5171

ALUMINIUM PARALLEL SLIDE & TILT 130 KG ALÜMİNYUM PARALEL ÇEK SÜR 130 KG					
SIZE / ÖLÇÜLER	WIDTH / GENİŞLİK				
HEIGHT / YÜKSEKLİK	600-850	851-1100	1001-1350	1351-1600	1601-1850
730-2400	09-5010	09-5011	09-5012	09-5013	---

ALUMINIUM PARALLEL SLIDE & TILT 150 KG ALÜMİNYUM PARALEL ÇEK SÜR 150 KG					
SIZE / ÖLÇÜLER	WIDTH / GENİŞLİK				
HEIGHT / YÜKSEKLİK	600-850	851-1100	1001-1350	1351-1600	1601-1850
895-1200	09-5014	09-5015	09-5016	09-5017	---
1200-2400	09-5018	09-5019	09-5020	09-5021	---

ALUMINIUM PARALLEL SLIDE & TILT 200 KG ALÜMİNYUM PARALEL ÇEK SÜR 200 KG					
SIZE / ÖLÇÜLER	WIDTH / GENİŞLİK				
HEIGHT / YÜKSEKLİK	600-850	851-1100	1001-1350	1351-1600	1601-1850
895-1200	09-5022	09-5023	09-5024	09-5025	09-5026
1200-2400	09-5027	09-5028	09-5029	09-5030	09-5031

ALUMINIUM FOLDING DOOR 80 KG / ALÜMİNYUM KATLANIR KAPI 80 KG			
	ŞEMA	RAY	KOD
3 Kanat (2 Kanat Bir Yöne - 1 Kanat Ayr)	321	3 mt	09-5051
3 Kanat (Tek Yöne Toplanır)	330	3 mt	09-5052
4 Kanat (3 Kanat Bir Yöne - 1 Kanat Ayr)	431	4 mt	09-5053
5 Kanat (4 Kanat Bir Yöne - 1 Kanat Ayr Yöne)	541	5 mt	09-5054
5 Kanat (3 Kanat Bir Yöne - 2 Kanat Ayr Yöne)	532	5 mt	09-5055
5 Kanat (Tek Yöne Toplanır)	550	5 mt	09-5056
6 Kanat (3 Kanat Bir Yöne - 3 Kanat Ayr Yöne)	633	6.7 mt	09-5057
6 Kanat (5 Kanat Bir Yöne - 1 Kanat Ayr Yöne)	651	6.7 mt	09-5058
7 Kanat (4 Kanat Bir Yöne - 3 Kanat Ayr Yöne)	743	6.7 mt	09-5059
7 Kanat (6 Kanat Bir Yöne - 1 Kanat Ayr)	761	6.7 mt	09-5060
7 Kanat (Tek Yöne Toplanır)	770	6.7 mt	09-5061

ISO 9001 SERTİFİKASI



QUALICOAT SERTİFİKASI



QUALANOD SERTİFİKASI



IATF 16949 SERTİFİKASI



TSE HASSAS PROFİLLER BELGESİ



TSE YÜZEY İŞLEM BELGESİ



TSE İMALATI YETERLİLİK BELGESİ



ISO 14001



OHSAS 18001 BELGESİ



FABRİKA ÜRETİM UYGUNLUK



CE BELGESİ



GOST-R SERTİFİKASI

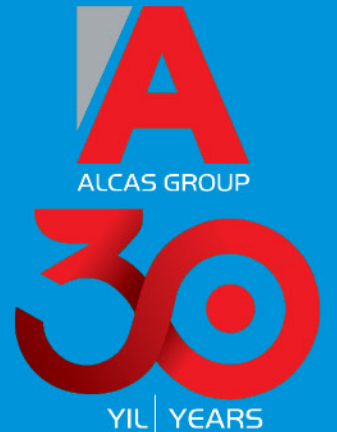

ALCAS®

ALUMINIUM PROFILE SYSTEMS

444 36 44

alcas@alcas.com.tr

www.alcas.com.tr

Kaya Milenium Plaza Kat 7 No:139 Beykent / İstanbul +90212 871 1771

Velimeşe Islah OSB 129.Sok.11/1 Ergene / Tekirdağ +90282 674 5175

alcasmetal

alcasaluminyum

alcasmetal

alcasmetal

alcasmetal



All designs, profiles and accessories listed in this catalog are © copyrighted and ® registered products. May not be copied, altered or posted online by any means.
Bu katalogta yer alan tasarımlar, profiller ve aksesuarlar tescilli ve patentli ürünlerimizdir. Hiçbir şekilde kopyalanamaz ve taktit edilemez.

Dünyanın yeni profil sistemi

