

Profil Katalođu 2020
Profile Catalogue



ALCAS[®]
ALUMINIUM PROFILE SYSTEMS

YALITIMLI KAPI&PENCERE

Isolated Windows&Door

World's new profile systems





Factory / Üretim Tesisi / Çorlu - TEKİRDAĞ



1. Press Line / 2750 US Ton 1. Pres Hattı



2. Press Line / 1800 US Ton 2. Pres Hattı



3. Press Line / 1540 US Ton 3. Pres Hattı



ALCAS® Çorlu - Tekirdağ'da 42.000 m2 arazi üzerinde alüminyum üretimi için özel olarak inşa edilmiş 36.000 m2 kapalı alana sahip tesise sahip olup, uzman 270 personel görev almaktadır. Tesismizde 2.750 Ton 1800 Ton ve 1540 Ton olarak 3 ekstrüzyon presi bulunmaktadır. Yıllık üretim kapasitemiz 22.000 TON olup DU 10 mm'den DU 310 mm'e kadar her türlü profil üretimi yapılabilmektedir. Yüzey işlemsiz pres profilleri 13.6 m.'ye kadar termikleme, paketleme ve sevkiyat imkanı mevcuttur.

Eloksal tesismiz yıllık 11.000 ton profile eloksal yapma kapasitesine sahiptir. Eloksal banyolarımızın boyu 8 m olup net 7.60 cm. uzunluğa kadar olan profiller eloksal yapılabilmektedir. Tesismizde standart 12 mikron kaplamanın yanı sıra isteğe bağlı özel olarak 5 mikrondan 30 mikrona kadar eloksal işlemi yapılabilmektedir. Türkiye'nin en ileri teknolojisine sahip eloksal tesismizde polisajlı parlak profiller, satınel mat profiller ile gümüş, sarı, bronz, siyah renkli eloksalları aynı anda yapmak mümkün olmaktadır. Elektrostatik boya hattımız 36 m fırın uzunluğuna ve çift boya kabineye sahip olup yıllık 7.000 ton alüminyum profilin 180 çeşit RAL renklerinin boyanabildiği hattımızda 7.80 cm. uzunluğa kadar profiller boyanabilmektedir.

Alüminyum profil sistemlerimizin tüm kalıpları fabrikamız bünyesindeki kalıphanemizde gelişmiş CNC makinelerle ve ekipmanlarla donatılmış olup yıllık kalıp üretim kapasitemiz 1.400 adettir.

Firmamızın kendi AR-GE departmanında geliştirmekte olduğu sistemlerin kalıpları, büyük bir hassasiyetle üretilmekte çeşitli test aşamalarından sonra profil üretimine girilmektedir.

Kesme, delme, bükme, çapak alma, barkodlama gibi işlemlerin yapılabildiği gelişmiş makina parkına sahip konfeksiyon hattımızda, müşterilerimizin talep ettiği her türlü profil işleme işleri yapılmakta ve isteğe uygun olarak paketlenmektedir. İmalatımız da 6063,6060 ,6061,6005, 6082 alaşımı hammaddeden F18 den F31 e kadar çeşitli sertlikte ,su soğutmalı üretim yapabilmekteyiz. Ürettiğimiz tüm ürünler DIN 12020, 12021, 12022 normlarına uygundur.

Alüminyum giydirme cephe, kapı, pencere sektöründe uzman olan firmamızın tesismizdeki üretimini %65'i kapı, pencere, cephe profilleri gibi mimari ürünlerden oluşmaktadır. Mimar ve mühendislerden oluşan 12 kişilik teknik ekibimiz yeni sistemler üretmekte, varolan sistemleri de geliştirmektedir. Tüm sistemlerimiz çeşitli deneyler ve testlerden geçirilmekte sorunsuz ürünü size ulaştırmayı hedefleyen ARGE departmanımız sizlerden gelecek her türlü talebi hızla yerine getirmeye hazırdır. Üretimimizin %67'ini başta Amerika ve Avrupa ülkeleri olmak üzere 28 ülkeye ihraç eden firmamızın yurt içinde de 300'ü aşkın bayii ve kurumsal müşteriye hizmet vermektedir. Şirketimiz birçok ülkede bulunan bağılantı ve ofislerimiz vasıtasıyla hızlı, yerel ve güvenilir hizmet sunmaktadır.

TSE, GOST, GOST-R, CE, CPTP, ISO 9001:2008, QUALONAT, QUALICOAT, IFT ROSENHEIM, ISO 18001, ISO 14001, IATF 16949, EN 15088 gibi bir çok kalite ve standartlar belgesine sahip fabrikamızın yüksek kapasitesi, profil serilerindeki geniş yelpaze ve üretim tecrübesi ile sizlere en iyi profil ve profil sistemlerini sunmaya hazırdır.

ALCAS® ALUMINIUM PROFILE SYSTEMS 270 qualified personnel is working in the factory which is specially built and landed on a total area of 42.000 m2 and a closed area of 36.000 m2 in Çorlu Tekirdağ. We have two extrusion presses in the factory, 2.750 UST 1800 UST and 2540 UST. The annual production capacity is 22.000 tons and all kind of profiles which have width of 10 mm to 310 mm can be produced. Max. Mill Finish surface aged to T6 profile length is 13.6 meters.

Our anodic oxidation plant has got the capacity of making 11.000 tons of profile anodic oxidation annually. The length of our anodic oxidation baths is 8 meters and there the profiles till the length of 7.60 cm net can be made anodic oxidation. In our plant besides the standard 12 micron of coating, the anodic oxidation process from 5 micron to 30 micron depending on the request can be made peculiarly. It is possible to make polished luminous profiles, satin opaqued profiles and silver, yellow, bronze, black colored anodic oxidations at the same time in our anodic oxidation plant having the latest technology of Turkey. Our electrostatic paint line has got an oven length of 3x6 meters and double paint cabins and the profiles until the length of 7.80 cm can be painted in our line in which 180 kinds of RAL colors of 7.000 tons of aluminum profiles can be painted.

All the moulds of our aluminum profile systems are made with the developed CNC machine tools and equipments in our molding room present within the constitution of our factory and our annual capacity of mould production is 1.400 pieces. The molds of the systems which are developed in its own Research & Development department of our firm are produced with great precision and the profile production is started following various test stages. All kinds of profile processing works requested by our

customers are made in our confection line having the developed machinery line where the processes such as cutting, boring, bending, burr removing, bar coding can be made and are packed in conformity with the demand.

We can make water cooled production in various hardness in our production from 18 to 31 of the 6063, 6060, 6061, 6005, 6082 alloyed raw materials. All the products that we produce are in conformity with the norms of DIN 12020, 12021, 12022.55% of the production in our plant of our firm that is experienced in the aluminum curtain wall, door, window sectors consist of the architectural products such as doors, windows, face wall profiles. Our technical team of 12 persons consisted of Architectures and Engineers produce new systems and change the currently existing systems. All of our systems are being passed through various experiments and tests and our Development & Search department which aims to reach the products without any problem to you, is ready to perform any kind of demand to be received from you rapidly. Our company which exports 70% of its production to 28 countries to the European countries and USA at the first hand also has been giving service to vendors and corporate customers exceeding 300 inside the country. Our company, through our offices in many countries, and the connection fast, local and reliable service provides.

Our factory, which has got a lot of certificates of quality and standards like TSE, GOST, GOST-R, CE, CPTP, ISO, QUALONAT, QUALICOAT, IFT ROSENHEIM, ISO 18001, ISO 14001, IATF 16949, EN 15088 is ready to submit you the best profiles and profile systems along with its high capacity, its wide range at the profile series and the production experience.

Shipping and Packaging / Sevkiyat ve Paketleme

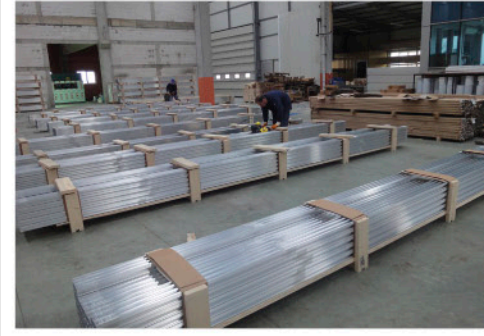

Shipping and Packaging / Sevkiyat ve Paketleme



Die Shop / Kalıphane



Mechanical Processes / Mekanik İşlemler



Electrostatic Paint Line / Elektrostatik Boya Hattı



Anodizing Line / Eloksal Hattı



Die Archive / Kalıp Arşivi



Wood Coating Unit / Ahşap Kaplama Ünitesi

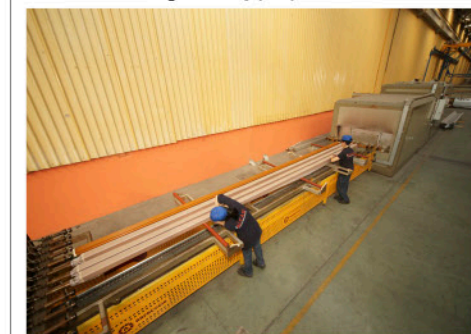

Mechanical Processes / Mekanik İşlemler



Project Name / Proje Adı : Dönerci Ali Usta
 System / Sistem : AWG64
 City / Şehir : Maltepe - İstanbul / TÜRKİYE



AWG64

Alcas Concealed Vent 64 mm Window
 Alcas Gizli Kanat Pencere Sistemi 64 mm

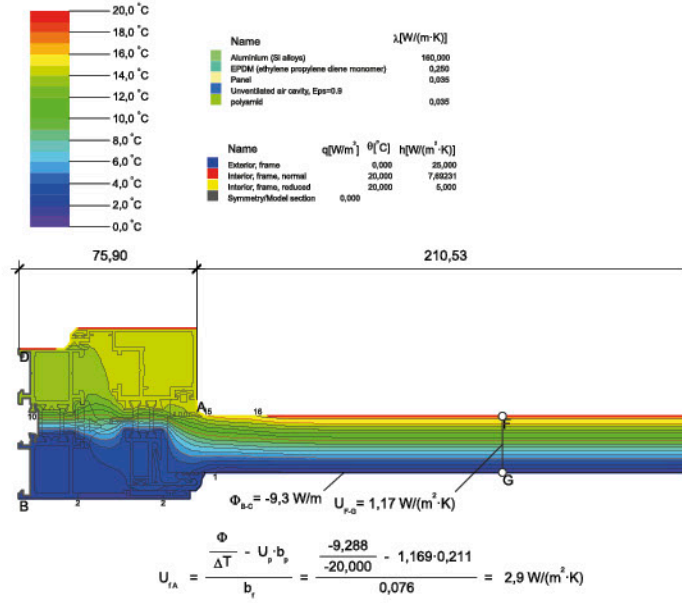
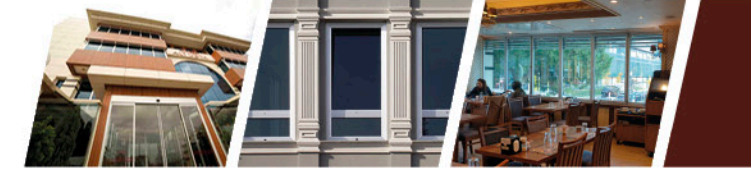

ALCAS' AWG64 pencere sistemleri; 1.5 ve 2 mm et kalınlığıyla üretilmekte olup, gerek zarif görünümü, gerekse mükemmel ısı yalıtım değerleriyle ekonomik ve estetik bir seridir.

ALCAS'ın diğer tüm doğrama serileriyle aynı conta ve aksesuarların, çita, adaptör, köşe takozu profillerinin kullanılması bakımından uygulamalar için gerek stok, gerek imalat esnasındaki karmaşayı engellemektedir.

Dıştan düz, içten oval hatlara sahip AWG64 serisi 22 mm'lik ısı yalıtım bariyeri ile ısı geçirim katsayısı düşürülerek mekanlarında ısı ve ses yalıtımı düşünenler için vazgeçilmez bir seridir.

ALCAS' AWG64, which is the thermally isolated type of AW series, is produced with 2 mm wall thickness and is a very economical and aesthetic series with its elegant appearance and perfect thermal isolation values. All of the gaskets, accessories, beads, adaptors, and corner cleats of the other.

ALCAS' window and door system series can be commonly used in this series, so this advantage can prevent the unnecessary profile and accessory stock and proves an easy installation.

The AWG64 series, which has a linear appearance on the outside and oval appearance on the inner side, has 22 mm thermal barriers to decrease the thermal conductivity coefficient of the system. So this series is indispensable for the people who are expecting good noise and thermal isolation.

Descriptions / Tanımlamalar

Profile type description		Profil tip tanımlamaları	
A Brand ALCAS'	Marka ALCAS'	F Frame	Kasa
WG System Type Window	Sistem Tipi Pencere	M Meeting Rail	Orta Kayıt
64 Series Length	Seni Genişliği	V Vent	Kanat
F Profile Type	Profil Tipi	A Adapter	Adaptör
01 Group Location	Gruptaki Yeri	C Cover	Kapak
		K Basalt	Tekmelik
		G Glazing Bead	Cam Çıtası

Symbols / Semboller

	Corner block assembly with 45° cutting process 45° kesim işlemi köşe takozu ile birleştirme		Milling process of merging with the vertical connection Kertme işlemi dik bağlantı ile birleştirme
--	--	--	---

ALCAS®

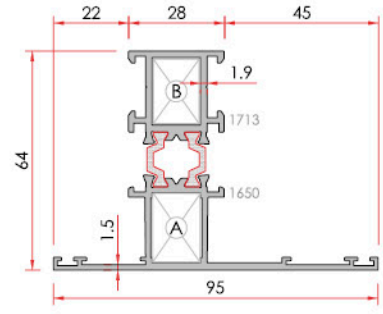

Frame
Kasa

System Code	Profile No	Weight kg
AWG64 TF 1501	1650-1713	1.683
Jxx cm ²	28.3	Jyy cm ² 15.7
A	AKB-1328-19	
B	AKB-1328-19	

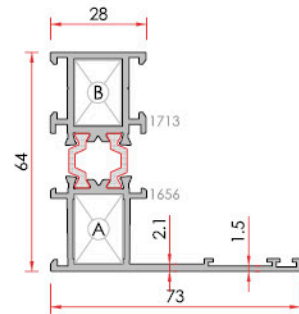

Frame
Kasa

System Code	Profile No	Weight kg
AWG64 TF 1502	1656-1713	1.574
Jxx cm ²	29.06	Jyy cm ² 9.7
A	AKB-1328-19	
B	AKB-1328-19	

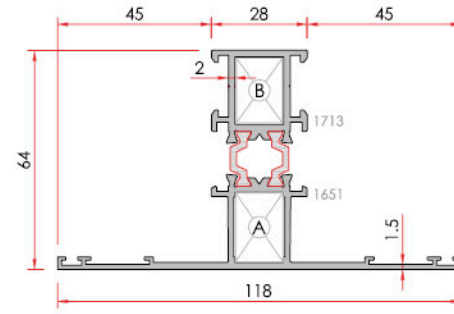

Meeting Rail
Orta Kayıt

System Code	Profile No	Weight kg
AWG64 TM 1501	1651-1713	1.823
Jxx cm ²	28.8	Jyy cm ² 28.0
A	AKB-1328-19	
B	AKB-1328-19	
A	30x30x2mm-18.8	
B	AOB-1324-13.8	

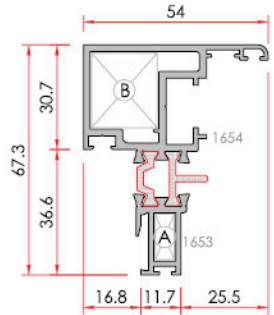

Vent
Kanat

System Code	Profile No	Weight kg
AWG64 TV 1501	1653-1654	1.506
Jxx cm ²	21.0	Jyy cm ² 7.3
A	AKB-1097-13.6	
B	AKB-1730-22.3	

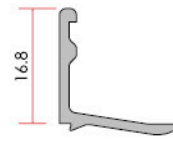

Glazing Bead
Kanat Cam Çıta

System Code	Profile No	Weight kg
AWG64 A 01	1652	0.145

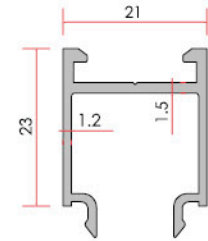

Frame Dead
Kasa Çıta Adaptör

System Code	Profile No	Weight kg
AWG64 A 02	1655	0.314

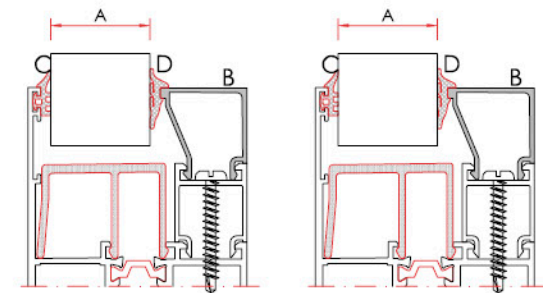

DOUBLE VENT WINDOW VIEW & DETAILS
ÇİFT KANAT PENCERE GÖRÜNÜŞ VE DETAYLARI

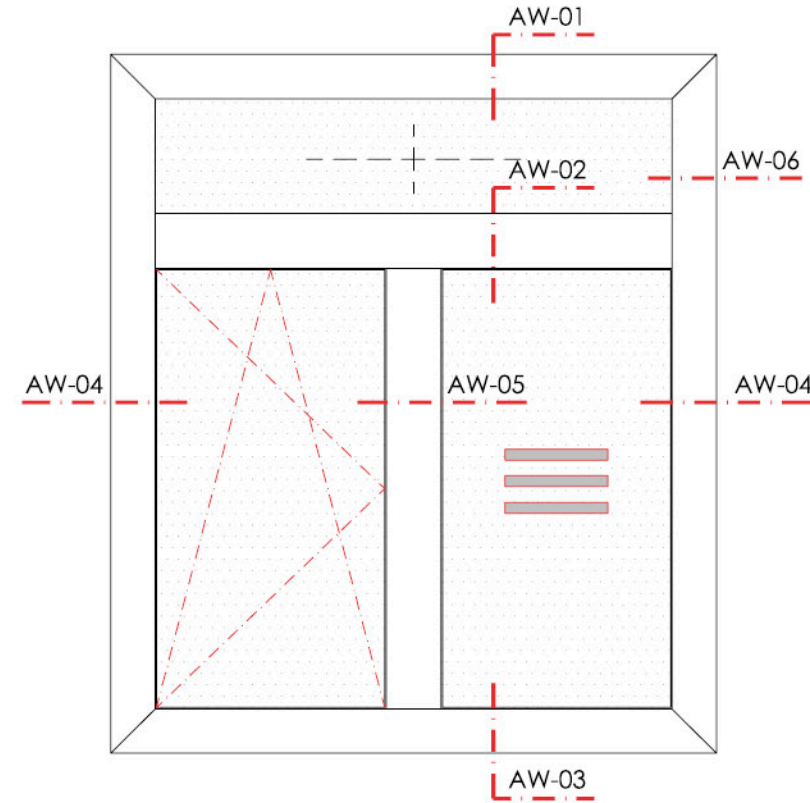

Exterior View - Dış Görünüş

Double Axisvent Dimension Çift Eksen Kanat Ölçüleri	Width / Genişlik	Height / Yükseklik
	401-1300 mm	480-1800 mm
Double Axisvent Weight Çift Eksen Kanat Ağırlığı	Max. 90 kg	
Glass Thickness Cam Kalınlığı	Max. 28 mm	

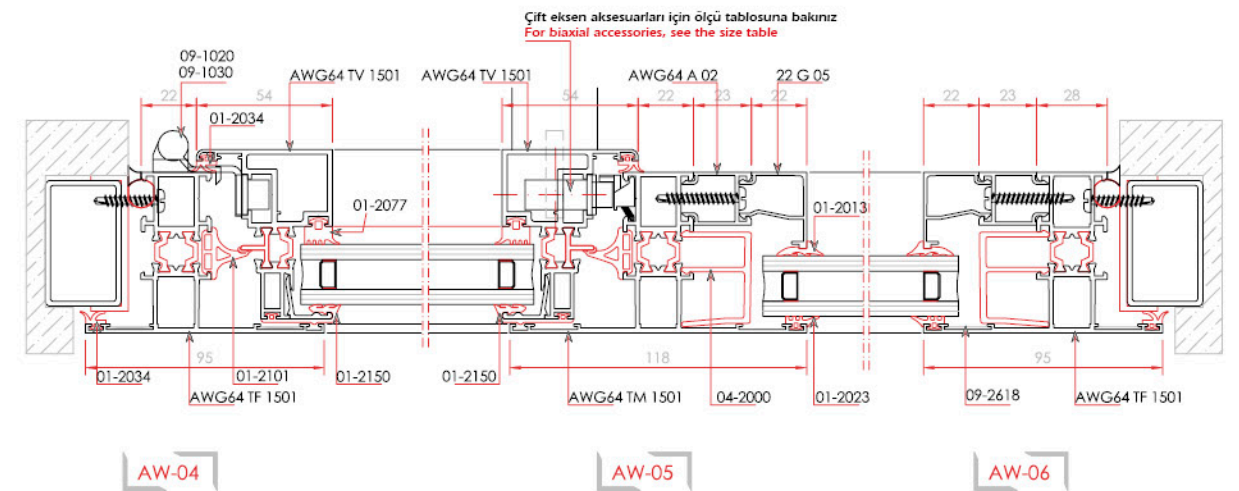
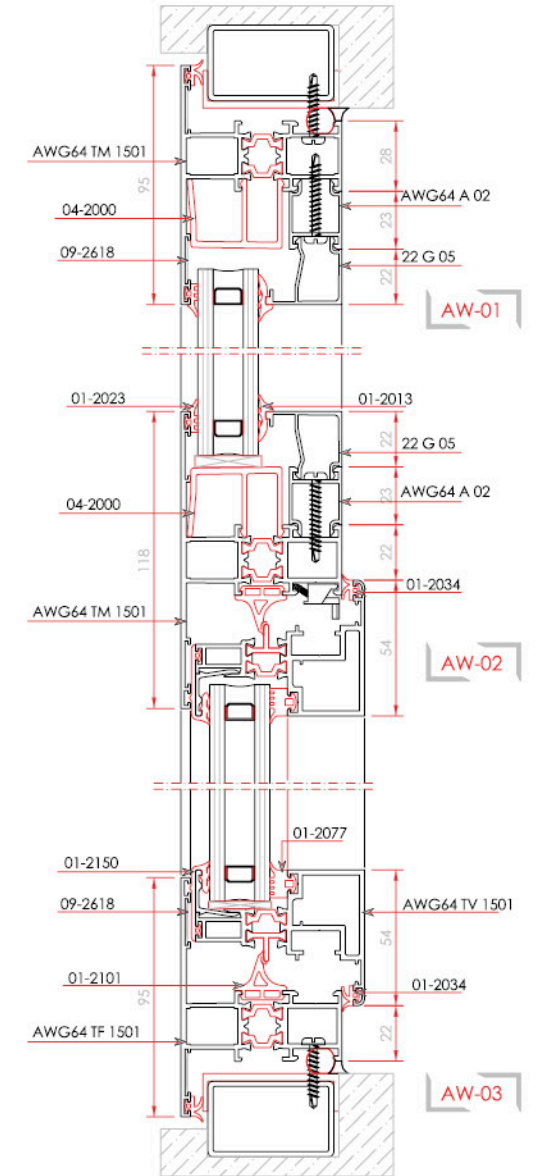

A	B	D	C	F	E
		01-2013	01-2005	01-2023	01-2150
		01-1003	01-2075	01-2077	01-2079
		3-3.5 mm	4-6 mm	3 mm	
28 mm	22 G 04	●	●	●	●
26 mm	22 G 08	●	●	●	●
24 mm	22 G 05	●	4-5 mm	●	●
22 mm	22 G 05	●	●	●	●

PARALLEL SLIDE & TILT VIEW & DETAILS
PARALEL ÇEK-SÜR GÖRÜNÜŞ VE DETAYLARI

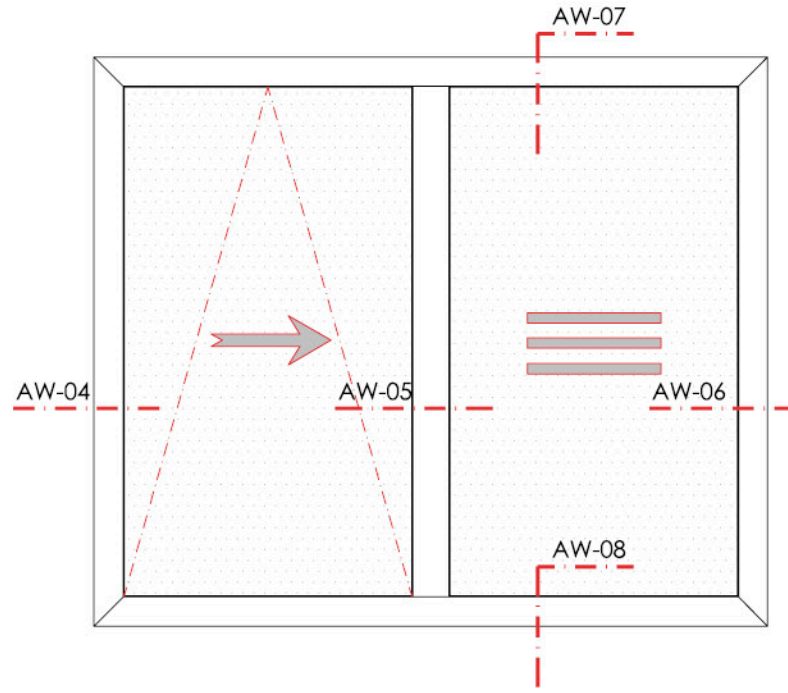

Exterior View - Dış Görünüş

Parallel Slide & Tilt Vent Dimensions Paralel Çek-Sür Kanat Ebatları 130 kg	Width / Genişlik	Height / Yükseklik
	600-1500 mm	730-2000 mm
Parallel Slide & Tilt Vent Dimensions Paralel Çek-Sür Kanat Ebatları 150 kg	Width / Genişlik	Height / Yükseklik
	600-1500 mm	895-2000 mm
Parallel Slide & Tilt Vent Dimensions Paralel Çek-Sür Kanat Ebatları 200 kg	Width / Genişlik	Height / Yükseklik
	600-1500 mm	895-2000 mm
Glass Thickness Cam Kalınlığı	Max. 28 mm	

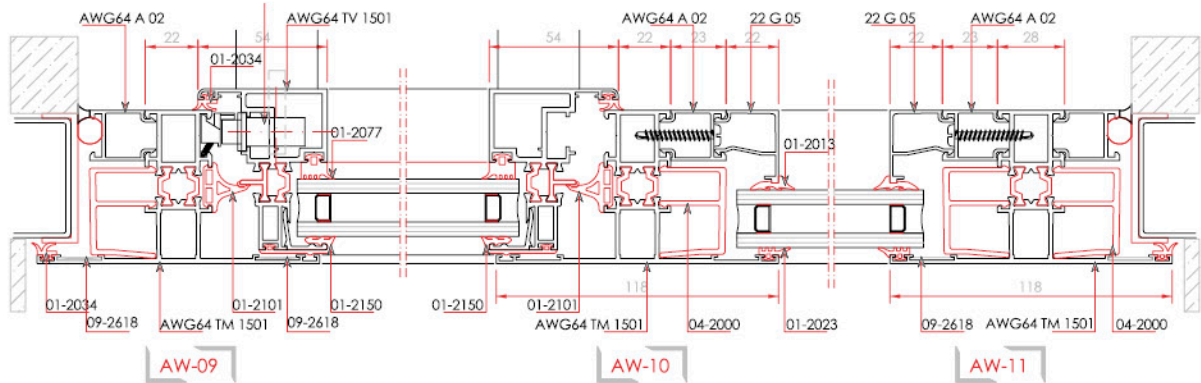
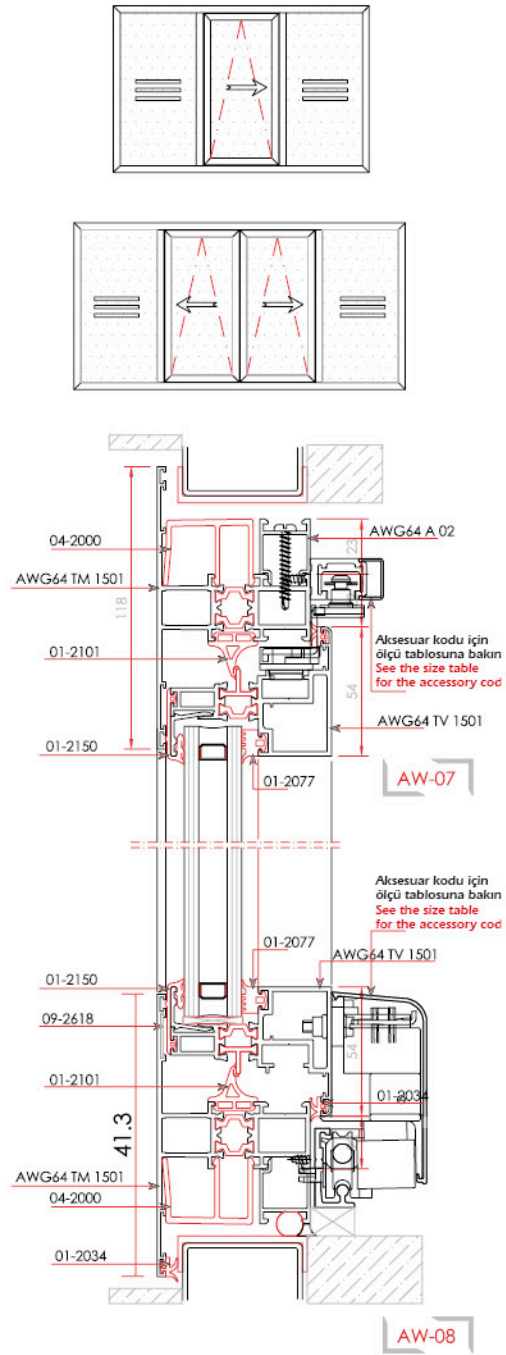

ALCAS®



ALCAS®



» GENERAL PROFILES & ACCESSORIES
GENEL PROFİLLER VE AKSESUARLAR

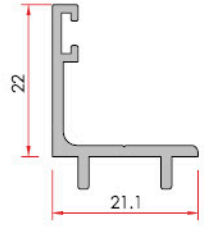

Corner Cleat
İlave Kulak

System Code	Profile No	Weight kg
AWD60 A 05	1610	0.224

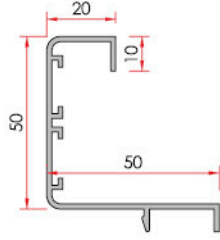

Sill Profile
Pervaz Profili

System Code	Profile No	Weight kg
AW50 A 11	1237	0.624

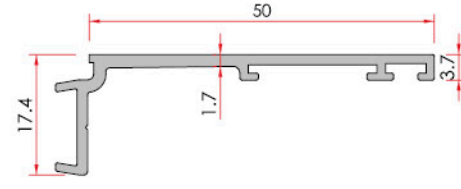

Sill Profile
Pervaz Profili

System Code	Profile No	Weight kg
AW50 A 12	1359	0.362

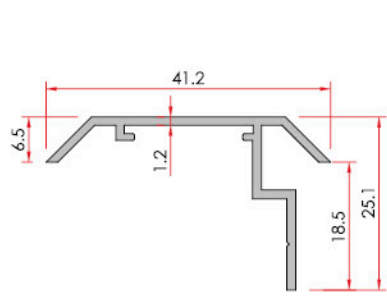

Sill Profile
Pervaz Profili

System Code	Profile No	Weight kg
AW50 A 13	1458	0.268

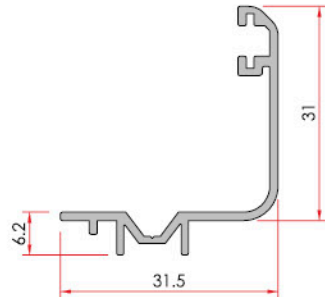

Sill Profile
Pervaz Profili

System Code	Profile No	Weight kg
AS50 A 06	1428	0.298

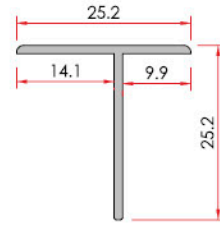

Sill Profile - T
Pervaz T Profili

System Code	Profile No	Weight kg
1874	1874	0.161

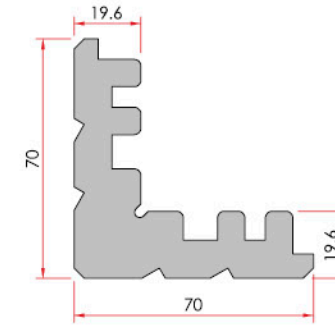

Corner Cleat
Köşe Takozu

System Code	Profile No	Weight kg
1730	1730	5.211

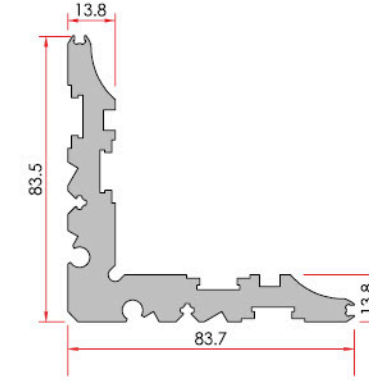

Corner Cleat
Köşe Takozu

System Code	Profile No	Weight kg
1328	1328	4.110

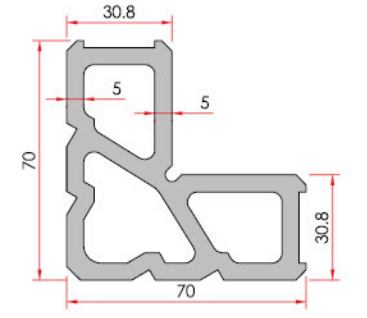

Corner Cleat
Köşe Takozu

System Code	Profile No	Weight kg
1329	1329	4.388

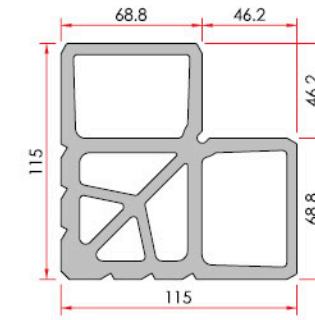

Corner Cleat
Köşe Takozu

System Code	Profile No	Weight kg
1327	1327	12.201

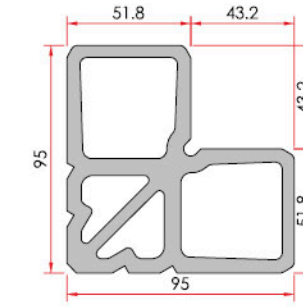

Corner Cleat
Köşe Takozu

System Code	Profile No	Weight kg
1330	1330	8.131

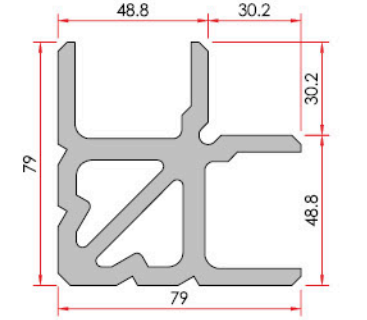

Corner Cleat
Köşe Takozu

System Code	Profile No	Weight kg
1963	1963	5.585

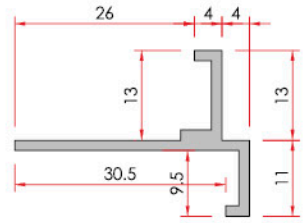

Sill Profile
Pervaz Profili

System Code	Profile No	Weight kg
2147	2147	0.274

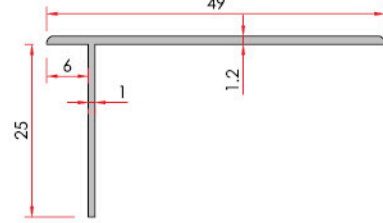

Sill Profile - T
Pervaz T Profili

System Code	Profile No	Weight kg
2815	2815	0.232

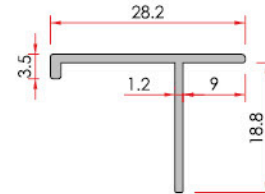

Sill Profile - T
Pervaz T Profili

System Code	Profile No	Weight kg
2844	2844	0.166

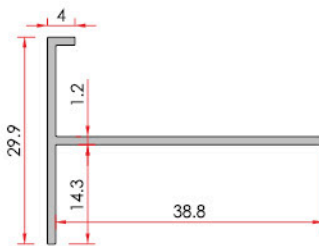

Sill Profile - T
Pervaz T Profili

System Code	Profile No	Weight kg
4284	4284	0.239

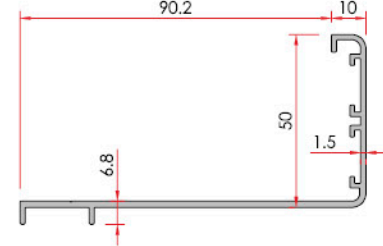

Sill Profile
Pervaz Profili

System Code	Profile No	Weight kg
4288	4288	0.860

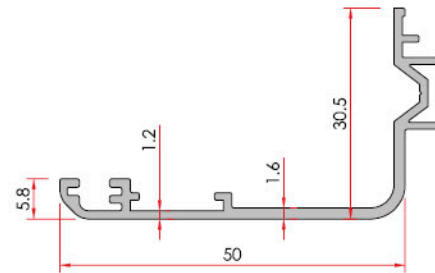

Sill Profile
Pervaz Profili

System Code	Profile No	Weight kg
1443	1443	0.407

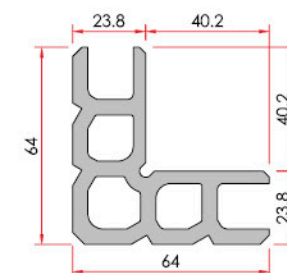

Corner Cleat
Köşe Takozu

System Code	Profile No	Weight kg
1630	1630	3.463

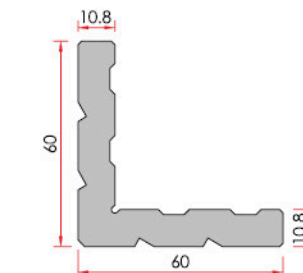

Corner Cleat
Köşe Takozu

System Code	Profile No	Weight kg
1034	1034	2.967

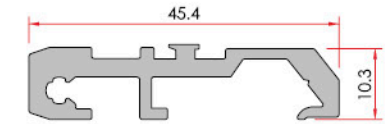

Meeting Rail Connection
Orta Kayıt Bağlantı

System Code	Profile No	Weight kg
1323	1323	0.583

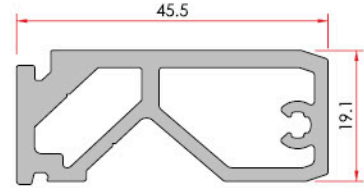

Meeting Rail Connection
Orta Kayıt Bağlantı

System Code	Profile No	Weight kg
1324	1324	0.971

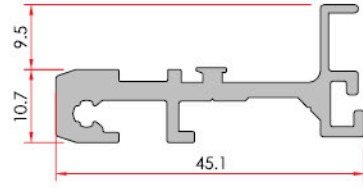

Meeting Rail Connection
Orta Kayıt Bağlantı

System Code	Profile No	Weight kg
1962	1962	0.636

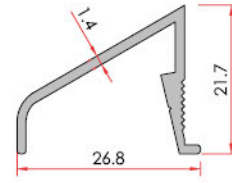

Drainage
Damlalık

System Code	Profile No	Weight kg
AW50 A 09	1321	0.234

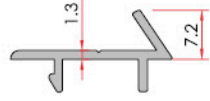

Corner Cleat
İlave Kulak

System Code	Profile No	Weight kg
AS50 A 01	1318	0.143

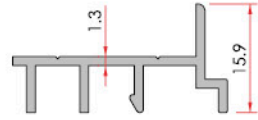

Outward Opening Fixed Adapter
Dışa Açılır Sabit Adaptör

System Code	Profile No	Weight kg
AW50 A 08	1317	0.241

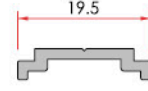

Stem
Tij

System Code	Profile No	Weight kg
AW50 A 10	1375	0.241

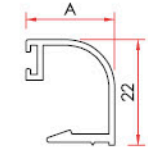
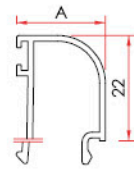
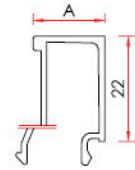



A	System Code	Profile No	Weight kg
10.3 mm	22 G 10	1378	0.229
15.1 mm	22 G 07	1611	0.261
16.3 mm	22 G 01	1367	0.265
17 mm	22 G 09	1613	0.268
20.3 mm	22 G 02	1366	0.278
21.3 mm	22 G 03	1368	0.285
23.5 mm	22 G 11	1616	0.300
25.3 mm	22 G 04	1369	0.300
26.3 mm	22 G 08	1612	0.309
30.3 mm	22 G 05	1370	0.329
34.3 mm	22 G 06	1371	0.343



A	System Code	Profile No	Weight kg
18.6 mm	22 RG 01	1956	0.258
21 mm	22 RG 02	1957	0.264
26 mm	22 RG 03	2924	0.287

A	System Code	Profile No	Weight kg
18.5 mm	22 RK 01	1958	0.220
21 mm	22 RK 02	1959	0.229
26 mm	22 RK 03	2923	0.247

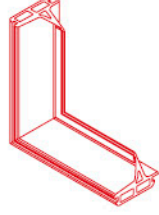
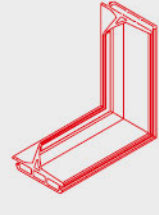
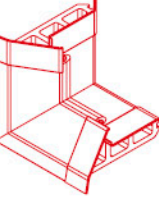
CODE / KOD	ACCESSORIES / AKSESUAR	DESCRIPTION / AÇIKLAMA
01-1003		3 mm Gasket 3 mm Conta 250 mt / Koli
01-2005		5 mm Gasket 5 mm Conta 235 mt / Koli
01-2013		3 mm Gasket 3 mm Conta 300 mt / Koli
01-2023		3 mm Gasket 3 mm Conta 375 mt / Koli
01-2027		5.5 mm Gasket 5.5 mm Conta 230 mt / Koli
01-2033		3 mm Gasket 3 mm Bini Conta 375 mt / Koli
01-2034		4.5 mm Gasket 4.5 mm Bini Conta 365 mt / Koli
01-2043		3 mm Gasket 3 mm Bini Conta 325 mt / Koli
01-2077		7 mm Gasket 7 mm Conta 135 mt / Koli

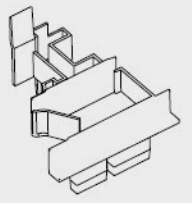
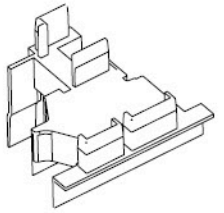

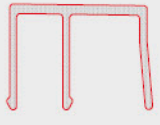
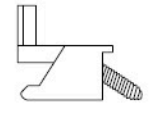
CODE / KOD	ACCESSORIES / AKSESUAR	DESCRIPTION / AÇIKLAMA
01-2079		9 mm Gasket 9 mm Conta 125 mt / Koli
01-2086		4 mm Gasket 4 mm Conta 187 mt / Koli
01-2095		4 mm Gasket 4 mm Conta 225 mt / Koli
01-2101		AW55 Middle Gasket AW 55 Orta Bini Conta 90 mt / Koli
01-2102		AW61 Middle Gasket AW61 Orta Bini Conta 60 mt / Koli
01-2103		AW69 Middle Gasket AW69 Orta Bini Conta 40 mt / Koli
01-2104		AW73 Middle Gasket AW73 Orta Bini Conta 35 mt / Koli
01-2105		AW65 Middle Gasket AW65 Orta Bini Conta 45 mt / Koli
01-2150		Gasket Conta 120 mt / Koli

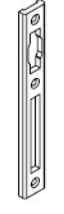
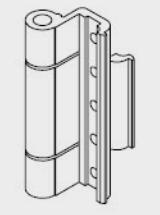
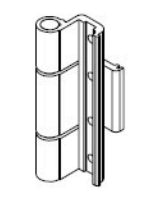
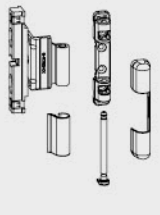

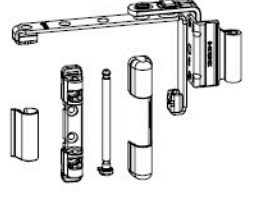
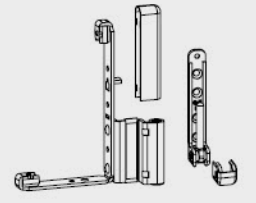
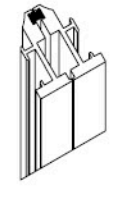
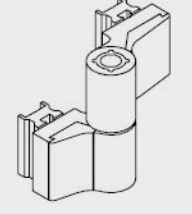
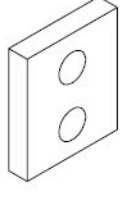
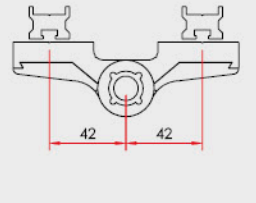
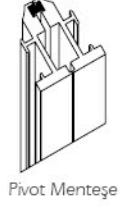

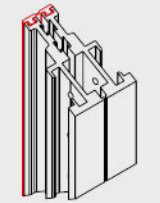
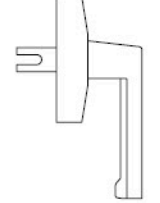
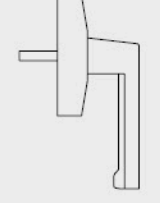
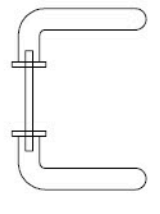
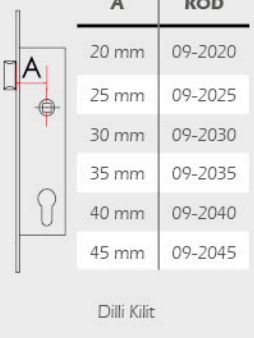
CODE / KOD	ACCESSORIES / AKSESUAR	DESCRIPTION / AÇIKLAMA
03-2001		AW55 - AWR64 - AWG64 Volcanised Gasket AW55 - AWR64 - AWG64 Köşe Kaynak Conta Pieces / Adet
03-2002		AW61 - AWR70 Volcanised Gasket AW61 - AWR70 Köşe Kaynak Conta Pieces / Adet
03-2009		AW73 Volcanised Gasket AW73 Köşe Kaynak Conta Pieces / Adet
03-2006		Drainage Caps Tahliye Kapağı Pieces / Adet
03-2010 03-2011 03-2012		Plastic Plug 12 mm Montaj Tapası 12 mm 03-2010 White / Beyaz 03-2011 Gray / Gri 03-2012 Brown / Kahverengi
03-2520		AW61 Adapter Cover AW61 Adaptör Kapak Pieces / Adet
03-2525		AW61 Adapter Cover AW61 Adaptör Kapak

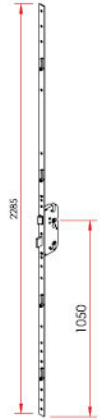
CODE / KOD	ACCESSORIES / AKSESUAR	DESCRIPTION / AÇIKLAMA
04-2000		Pvc Insulation Yalıtım Plastığı 3 mt / Adet 3 mt / Pieces
05-1003		Part Locking Ayarlı İspanyollet Karşılığı Pieces / Adet
06-1300		Locking Plate Makaralı Kilit Karşılığı Pieces / Adet
06-1301		Locking Plate Makaralı Kilit Karşılığı Pieces / Adet
09-1010 09-1011 09-1012 09-1013 09-1014		Hinge For Aluminium Canal Pencere Menteşesi (Alüminyum kanal için) 09-1010 Anodized / Eloksal 09-1011 White / Beyaz 09-1120 Brown / Kahverengi 09-1013 Raw / Ham 09-1014 Special / Özel Renk
09-1020 09-1021 09-1022 09-1023 09-1024		Hinge For PVC Canal Pencere Menteşesi (PVC kanal için) 09-1020 Anodized / Eloksal 09-1021 White / Beyaz 09-1022 Brown / Kahverengi 09-1023 Raw / Ham 09-1024 Special / Özel Renk
09-1030 09-1031 09-1032		Stell Middle Hinge For Pvc Canal Çelik Orta Menteşe (PVC kanal için) 09-1030 Gray / Gri 09-1031 White / Beyaz 09-1032 Brown / Kahverengi

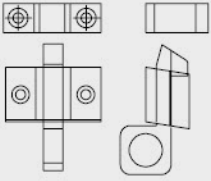

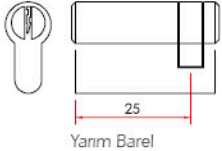
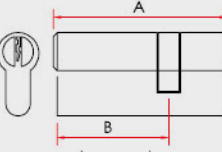
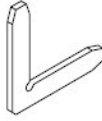
CODE / KOD	ACCESSORIES / AKSESUAR	DESCRIPTION / AÇIKLAMA
09-1035 09-1036 09-1037		Stell Top Hinge For Pvc Canal PVC Kanal İçin Çelik Üst Menteşe 09-1035 Gray / Gri 09-1036 White / Beyaz 09-1037 Brown / Kahverengi
09-1040 09-1041 09-1042		Stell Bottom Hinge For Pvc Canal PVC Kanal İçin Çelik Alt Menteşe 09-1040 Gray / Gri 09-1041 White / Beyaz 09-1042 Brown / Kahverengi
09-1135 09-1136 09-1137 09-1138 09-1139		Hinge Pivot For AW61 AW61 Pivot Menteşe 09-1135 Anodized / Eloksal 09-1136 White / Beyaz 09-1137 Brown / Kahverengi 09-1138 Raw / Ham 09-1139 Special / Özel Renk
09-1100 09-1101 09-1102 09-1103 09-1104		Door Hinges Kapı Menteşesi 09-1100 Anodized / Eloksal 09-1101 White / Beyaz 09-1102 Brown / Kahverengi 09-1103 Raw / Ham 09-1104 Special / Özel Renk
09-1110 09-1111 09-1112 09-1113 09-1114		Door Hinge Plate Kapı Menteşesi Beslemesi 09-1110 Anodized / Eloksal 09-1111 White / Beyaz 09-1112 Brown / Kahverengi 09-1113 Raw / Ham 09-1114 Special / Özel Renk
09-1120 09-1121 09-1122 09-1123 09-1124		Door Hinges Kapı Menteşesi 09-1120 Anodized / Eloksal 09-1121 White / Beyaz 09-1122 Brown / Kahverengi 09-1123 Raw / Ham 09-1124 Special / Özel Renk
09-1130 09-1131 09-1132 09-1133 09-1134		Hinge Pivot For AW55 AW55 Pivot Menteşe 09-1130 Anodized / Eloksal 09-1131 White / Beyaz 09-1132 Brown / Kahverengi 09-1133 Raw / Ham 09-1134 Special / Özel Renk

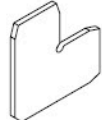
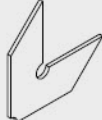
CODE / KOD	ACCESSORIES / AKSESUAR	DESCRIPTION / AÇIKLAMA
09-1145 09-1146 09-1147 09-1148 09-1149		Hinge Pivot For AW69 AW69 Pivot Menteşe 09-1145 Anodized / Eloksal 09-1146 White / Beyaz 09-1147 Brown / Kahverengi 09-1148 Raw / Ham 09-1149 Special / Özel Renk
09-1500 09-1501 09-1502 09-1503 09-1504		Window Handle (Cremone) Eksantrik İspanyollet Kolu 09-1500 Anodized / Eloksal 09-1501 White / Beyaz 09-1502 Brown / Kahverengi 09-1503 Raw / Ham 09-2704 Special / Özel Renk
09-1520 09-1521 09-1522 09-1523 09-1524		Window Handle Pencere Kolu 09-1520 Anodized / Eloksal 09-1521 White / Beyaz 09-1522 Brown / Kahverengi 09-1523 Raw / Ham 09-1524 Special / Özel Renk
09-1560 09-1561 09-1562 09-1563 09-1564		Door Handle Kapı Kolu 09-1560 Anodized / Eloksal 09-1561 White / Beyaz 09-1562 Brown / Kahverengi 09-1563 Raw / Ham 09-1564 Special / Özel Renk
09-2020 09-2025 09-2030 09-2035 09-2040 09-2045		Lack With Latch Dilli Kilit Pieces / Adet

CODE / KOD	ACCESSORIES / AKSESUAR	DESCRIPTION / AÇIKLAMA														
09-2070		Door Lock Gear Kilitli Kapı İspanyoleti Barel Aksı: 35 mm Pieces / Adet														
09-2080		Door Lock Gear Kilitli Kapı İspanyoleti Barel Aksı: 35 mm Pieces / Adet														
09-2220 09-2225 09-2230 09-2235 09-2240 09-2245	 <table border="1"> <thead> <tr> <th>A</th> <th>KOD</th> </tr> </thead> <tbody> <tr> <td>20 mm</td> <td>09-2220</td> </tr> <tr> <td>25 mm</td> <td>09-2225</td> </tr> <tr> <td>30 mm</td> <td>09-2230</td> </tr> <tr> <td>35 mm</td> <td>09-2235</td> </tr> <tr> <td>40 mm</td> <td>09-2240</td> </tr> <tr> <td>45 mm</td> <td>09-2245</td> </tr> </tbody> </table>	A	KOD	20 mm	09-2220	25 mm	09-2225	30 mm	09-2230	35 mm	09-2235	40 mm	09-2240	45 mm	09-2245	Lock With Roller Makaralı Dilli Kilit Pieces / Adet
A	KOD															
20 mm	09-2220															
25 mm	09-2225															
30 mm	09-2230															
35 mm	09-2235															
40 mm	09-2240															
45 mm	09-2245															
09-2400		Spring Catch Çarpma Kilit Pieces / Adet														

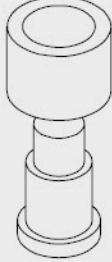
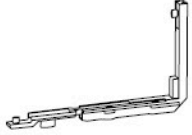
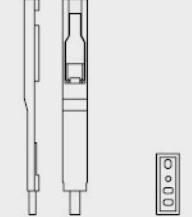
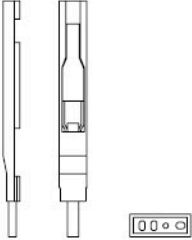
CODE / KOD	ACCESSORIES / AKSESUAR	DESCRIPTION / AÇIKLAMA												
09-2540		Lock Half Cylinder Yarım Barel Pieces / Adet												
09-2575 09-2585 09-2590	 <table border="1"> <thead> <tr> <th>KOD</th> <th>A</th> <th>B</th> </tr> </thead> <tbody> <tr> <td>09-2575</td> <td>75 mm</td> <td>40 mm</td> </tr> <tr> <td>09-2585</td> <td>85 mm</td> <td>50 mm</td> </tr> <tr> <td>09-2590</td> <td>90 mm</td> <td>55 mm</td> </tr> </tbody> </table>	KOD	A	B	09-2575	75 mm	40 mm	09-2585	85 mm	50 mm	09-2590	90 mm	55 mm	Lock Cylinder Asimetrik Barel Pieces / Adet
KOD	A	B												
09-2575	75 mm	40 mm												
09-2585	85 mm	50 mm												
09-2590	90 mm	55 mm												
09-2604		4.8 mm Alignment Corner 4.8 mm Köşe Gönye Pieces / Adet												
09-2609		9.3 mm alignment corner 9.3 mm Köşe Gönye Pieces / Adet												
09-2613		13.2 mm Alignment Corner 13.2 mm Köşe Gönye Pieces / Adet												
09-2615		18.2 mm Alignment Corner 18.2 mm Köşe Gönye Pieces / Adet												
09-2618		18.2 mm Alignment Corner 18.2 mm Köşe Gönye Pieces / Adet												

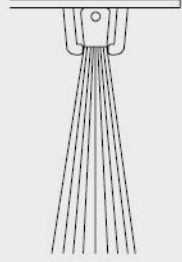
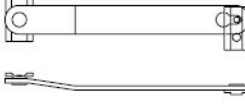
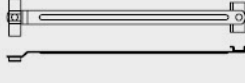
CODE / KOD	ACCESSORIES / AKSESUAR	DESCRIPTION / AÇIKLAMA
09-2700		Locking port İspanyolet Pimi Seti Pieces / Adet
09-2701		Corner Transmition İspanyol Köşe Aktarma Pieces / Adet
09-2702		Supporting Latch Çift Kanat Sürgü Pieces / Adet
09-2703		Supporting Latch (Short) Çift Kanat Sürgü (Kısa) Pieces / Adet

CODE / KOD	ACCESSORIES / AKSESUAR	DESCRIPTION / AÇIKLAMA																				
09-2704		Strip Brush Kapı Altı Fırçası Pieces / Adet																				
09-3100		Aluminium Awning Window Arm Vasistas Makas - Alüminyum Pieces / Adet																				
09-3101		Stainless Awning Window Arm Vasistas Makas - Paslanmaz Pieces / Adet																				
09-5073 09-5074 09-5075 09-5076 09-5077 09-5078 09-5079 09-5080 09-5081	 <table border="1"> <thead> <tr> <th>L</th> <th>CODE / KODE</th> </tr> </thead> <tbody> <tr> <td>400</td> <td>09-5073</td> </tr> <tr> <td>600</td> <td>09-5074</td> </tr> <tr> <td>800</td> <td>09-5075</td> </tr> <tr> <td>1000</td> <td>09-5076</td> </tr> <tr> <td>1200</td> <td>09-5077</td> </tr> <tr> <td>1400</td> <td>09-5078</td> </tr> <tr> <td>1600</td> <td>09-5079</td> </tr> <tr> <td>1800</td> <td>09-5080</td> </tr> <tr> <td>2000</td> <td>09-5081</td> </tr> </tbody> </table>	L	CODE / KODE	400	09-5073	600	09-5074	800	09-5075	1000	09-5076	1200	09-5077	1400	09-5078	1600	09-5079	1800	09-5080	2000	09-5081	
L	CODE / KODE																					
400	09-5073																					
600	09-5074																					
800	09-5075																					
1000	09-5076																					
1200	09-5077																					
1400	09-5078																					
1600	09-5079																					
1800	09-5080																					
2000	09-5081																					

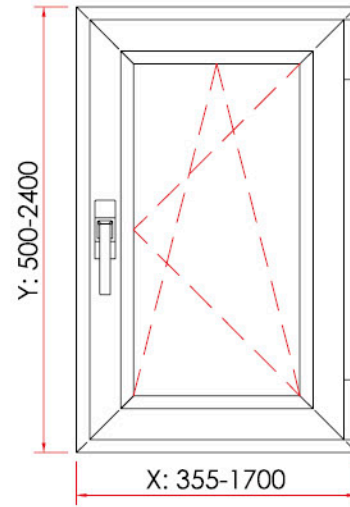
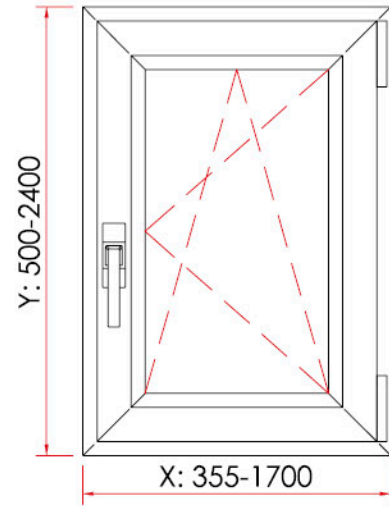

TILT-TURN WINDOWS / ALÜMİNYUM ÇİFT AÇILIM MEKANİZMASI					
SIZE / ÖLÇÜLER	WIDTH / GENİŞLİK				
HEIGHT / YÜKSEKLİK	355-700	701-1000	1001-1200	1201-1400	1401-1700
500 - 1200	09-5000	09-5001	09-5002	09-5003	09-5004
1201 - 2400	09-5005	09-5006	09-5007	09-5008	09-5009

TILT-TURN WINDOWS FOR PVC / PVC ÇİFT AÇILIM MEKANİZMASI						
SIZE / ÖLÇÜLER	WIDTH / GENİŞLİK					
HEIGHT / YÜKSEKLİK	401-500	501-750	751-950	951-1200	1201-1450	1451-1600
480 - 590	09-5100	09-5101	09-5102	09-5103	09-5104	09-5105
591 - 750	09-5106	09-5107	09-5108	09-5109	09-5110	09-5111
751-1200	09-5112	09-5113	09-5114	09-5115	09-5116	09-5117
1201-1450	09-5118	09-5119	09-5120	09-5121	09-5122	09-5123
1451-1950	09-5124	09-5125	09-5126	09-5127	09-5128	09-5129
1951-2450	09-5130	09-5131	09-5132	09-5133	09-5134	09-5135

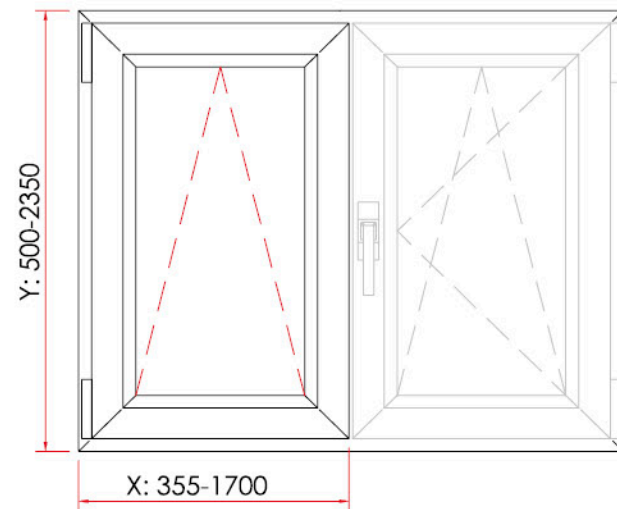
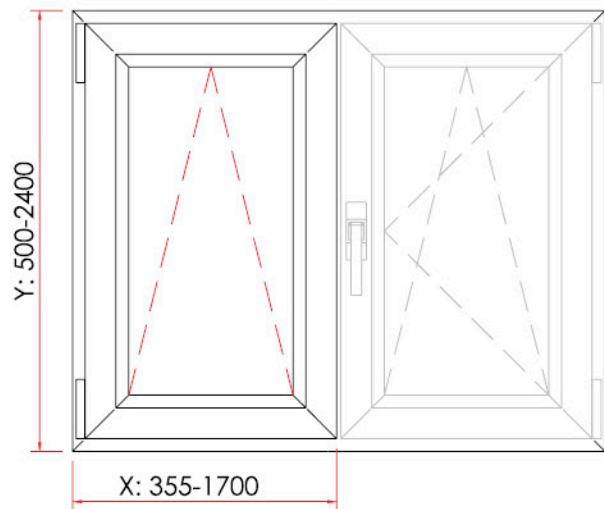

TILT-TURN WINDOWS FOR ALUMINIUM ALÜMİNYUM ÇİFT KANAT ÇİFT AÇILIM MEKANİZMASI					
SIZE / ÖLÇÜLER	WIDTH / GENİŞLİK				
HEIGHT / YÜKSEKLİK	355-700	701-1000	1001-1200	1201-1400	1401-1700
500-1200	09-5000	09-5001	09-5002	09-5003	09-5004
1201-2400	09-5005	09-5006	09-5007	09-5008	09-5009

TILT-TURN WINDOWS FOR PVC PVC ÇİFT KANAT ÇİFT AÇILIM MEKANİZMASI				
SIZE / ÖLÇÜLER	WIDTH / GENİŞLİK			
HEIGHT / YÜKSEKLİK	280-750	751-950	951-1200	1201-1600
470-720	09-5140	09-5141	09-5142	09-5143
721-850	09-5144	09-5145	09-5146	09-5147
851-1100	09-5148	09-5149	09-5150	09-5151
1101-1350	09-5152	09-5153	09-5154	09-5155
1351-1600	09-5156	09-5157	09-5158	09-5159
1601-1850	09-5160	09-5161	09-5162	09-5163
1851-2100	09-5164	09-5165	09-5166	09-5167
2101-2350	09-5168	09-5169	09-5170	09-5171

ALUMINIUM PARALLEL SLIDE & TILT 130 KG ALÜMİNYUM PARALEL ÇEK SÜR 130 KG					
SIZE / ÖLÇÜLER	WIDTH / GENİŞLİK				
HEIGHT / YÜKSEKLİK	600-850	851-1100	1001-1350	1351-1600	1601-1850
730-2400	09-5010	09-5011	09-5012	09-5013	---

ALUMINIUM PARALLEL SLIDE & TILT 150 KG ALÜMİNYUM PARALEL ÇEK SÜR 150 KG					
SIZE / ÖLÇÜLER	WIDTH / GENİŞLİK				
HEIGHT / YÜKSEKLİK	600-850	851-1100	1001-1350	1351-1600	1601-1850
895-1200	09-5014	09-5015	09-5016	09-5017	---
1200-2400	09-5018	09-5019	09-5020	09-5021	---

ALUMINIUM PARALLEL SLIDE & TILT 200 KG ALÜMİNYUM PARALEL ÇEK SÜR 200 KG					
SIZE / ÖLÇÜLER	WIDTH / GENİŞLİK				
HEIGHT / YÜKSEKLİK	600-850	851-1100	1001-1350	1351-1600	1601-1850
895-1200	09-5022	09-5023	09-5024	09-5025	09-5026
1200-2400	09-5027	09-5028	09-5029	09-5030	09-5031

PVC PARALLEL SLIDE & TILT 130 KG PVC PARALEL ÇEK SÜR 130 KG					
SIZE / ÖLÇÜLER	WIDTH / GENİŞLİK				
HEIGHT / YÜKSEKLİK	600-850	851-1100	1001-1350	1351-1600	1601-1850
730-2400	09-5180	09-5181	09-5182	09-5183	---

PVC PARALLEL SLIDE & TILT 150 KG PVC PARALEL ÇEK SÜR 150 KG					
SIZE / ÖLÇÜLER	WIDTH / GENİŞLİK				
HEIGHT / YÜKSEKLİK	600-850	851-1100	1001-1350	1351-1600	1601-1850
895-1200	09-5190	09-5191	09-5192	09-5193	---
1200-2400	09-5194	09-5195	09-5196	09-5197	---

PVC PARALLEL SLIDE & TILT 200 KG PVC PARALEL ÇEK SÜR 200 KG					
SIZE / ÖLÇÜLER	WIDTH / GENİŞLİK				
HEIGHT / YÜKSEKLİK	600-850	851-1100	1001-1350	1351-1600	1601-1850
895-1200	09-5200	09-5201	09-5202	09-5203	09-5204
1200-2400	09-5205	09-5206	09-5207	09-5208	09-5209

ALUMINIUM FOLDING DOOR 80 KG / ALÜMİNYUM KATLANIR KAPI 80 KG			
	RAY	RAY ALTTA	RAY ÜSTTE
3 Kanat (2 Kanat Bir Yöne - 1 Kanat Ayrı)	3 mt	09-5040	09-5051
3 Kanat (Tek Yöne Toplanır)	3 mt	09-5041	09-5052
4 Kanat (3 Kanat Bir Yöne - 1 Kanat Ayrı)	4 mt	09-5042	09-5053
5 Kanat (4 Kanat Bir Yöne - 1 Kanat Ayrı Yöne)	5 mt	09-5043	09-5054
5 Kanat (3 Kanat Bir Yöne - 2 Kanat Ayrı Yöne)	5 mt	09-5044	09-5055
5 Kanat (Tek Yöne Toplanır)	5 mt	09-5045	09-5056
6 Kanat (3 Kanat Bir Yöne - 3 Kanat Ayrı Yöne)	6 mt	09-5046	09-5057
6 Kanat (5 Kanat Bir Yöne - 1 Kanat Ayrı Yöne)	6 mt	09-5047	09-5058
6 Kanat (5 Kanat Bir Yöne - 1 Kanat Ayrı Yöne)	6.7 mt	09-5048	09-5059
7 Kanat (6 Kanat Bir Yöne - 1 Kanat Ayrı)	6.7 mt	09-5049	09-5060
7 Kanat (Tek Yöne Toplanır)	6.7 mt	09-5050	09-5061

PVC FOLDING DOOR 80 KG / PVC KATLANIR KAPI 80 KG			
	RAY	RAY ALTTA	RAY ÜSTTE
3 Kanat (2 Kanat Bir Yöne - 1 Kanat Ayrı)	3 mt	09-5220	09-5231
3 Kanat (Tek Yöne Toplanır)	3 mt	09-5221	09-5232
4 Kanat (3 Kanat Bir Yöne - 1 Kanat Ayrı)	4 mt	09-5222	09-5233
5 Kanat (4 Kanat Bir Yöne - 1 Kanat Ayrı Yöne)	5 mt	09-5223	09-5234
5 Kanat (3 Kanat Bir Yöne - 2 Kanat Ayrı Yöne)	5 mt	09-5224	09-5235
5 Kanat (Tek Yöne Toplanır)	5 mt	09-5225	09-5236
6 Kanat (3 Kanat Bir Yöne - 3 Kanat Ayrı Yöne)	6 mt	09-5226	09-5237
6 Kanat (5 Kanat Bir Yöne - 1 Kanat Ayrı Yöne)	6 mt	09-5227	09-5238
6 Kanat (5 Kanat Bir Yöne - 1 Kanat Ayrı Yöne)	6.7 mt	09-5228	09-5239
7 Kanat (6 Kanat Bir Yöne - 1 Kanat Ayrı)	6.7 mt	09-5229	09-5240
7 Kanat (Tek Yöne Toplanır)	6.7 mt	09-5230	09-5241

09-5070

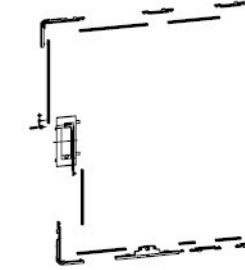

HORIZONTAL PIVOTED / YATAY PİVOT

09-5071

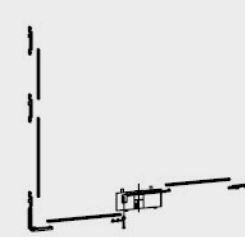

VERTICAL PIVOTED / DÜŞEY PİVOT

09-5072

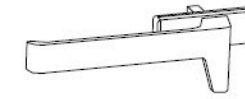

GEAR PIVOTED HANDLE / İSPANYOL PİVOT KOL

ISO 9001 SERTİFİKASI



QUALICOAT SERTİFİKASI



QUALANOD SERTİFİKASI



IATF 16949 SERTİFİKASI



TSE HASSAS PROFİLLER BELGESİ



TSE YÜZEY İŞLEM BELGESİ



TSE İMALATI YETERLİLİK BELGESİ



ISO 14001



OHSAS 18001 BELGESİ



FABRİKA ÜRETİM UYGUNLUK



CE BELGESİ



GOST-R SERTİFİKASI

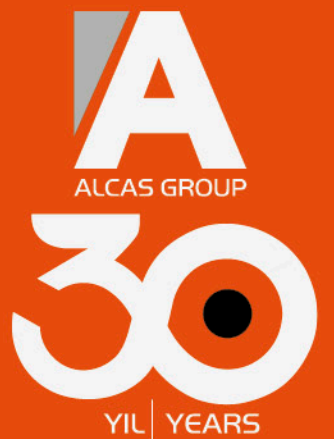

ALCAS®

ALUMINIUM PROFILE SYSTEMS

444 36 44

alcas@alcas.com.tr

www.alcas.com.tr

Kaya Milenium Plaza Kat 7 No:139 Beykent / İstanbul +90212 871 1771

Velimeşe Islah OSB 129.Sok.11/1 Ergene / Tekirdağ +90282 674 5175

alcasmetal

alcasaluminyum

alcasmetal

alcasmetal

alcasmetal



All designs, profiles and accessories listed in this catalog are © copyrighted and ® registered products. May not be copied, altered or posted online by any means.
Bu katalogta yer alan tasarımlar, profiller ve aksesuarlar tescilli ve patentli ürünlerimizdir. Hiçbir şekilde kopyalanamaz ve taktit edilemez.

Dünyanın yeni profil sistemi

