

Profil Katalođu 2020
Profile Catalogue



ALCAS[®]
ALUMINIUM PROFILE SYSTEMS

CEPHE SİSTEMLERİ

Façade Systems

World's new profile systems





Factory / Üretim Tesisi / Çorlu - TEKİRDAĞ



1. Press Line / 2750 US Ton 1. Pres Hattı



2. Press Line / 1800 US Ton 2. Pres Hattı



3. Press Line / 1540 US Ton 3. Pres Hattı



ALCAS® Çorlu - Tekirdağ'da 42.000 m2 arazi üzerinde alüminyum üretimi için özel olarak inşa edilmiş 36.000 m2 kapalı alana sahip tesise sahip olup, uzman 270 personel görev almaktadır. Tesismizde 2.750 Ton 1800 Ton ve 1540 Ton olarak 3 ekstrüzyon presi bulunmaktadır. Yıllık üretim kapasitemiz 22.000 TON olup DU 10 mm'den DU 310 mm'e kadar her türlü profil üretimi yapılabilmektedir. Yüzeyle işlemsiz pres profilleri 13.6 m.'ye kadar termikleme, paketleme ve sevkiyat imkanı mevcuttur.

Eloksal tesismiz yıllık 11.000 ton profile eloksal yapma kapasitesine sahiptir. Eloksal banyolarımızın boyu 8 m olup net 7.60 cm. uzunluğa kadar olan profiller eloksal yapılabilmektedir. Tesismizde standart 12 mikron kaplamanın yanı sıra isteğe bağlı özel olarak 5 mikrondan 30 mikrona kadar eloksal işlemi yapılabilmektedir. Türkiye'nin en ileri teknolojisine sahip eloksal tesismizde polisajlı parlak profiller, satıneli mat profiller ile gümüş, sarı, bronz, siyah renkli eloksalları aynı anda yapmak mümkün olmaktadır. Elektrostatik boya hattımız 36 m fırın uzunluğuna ve çift boya kabineye sahip olup yıllık 7.000 ton alüminyum profilin 180 çeşit RAL renklerinin boyanabildiği hattımızda 7.80 cm. uzunluğa kadar profiller boyanabilmektedir.

Alüminyum profil sistemlerimizin tüm kalıpları fabrikamız bünyesindeki kalıphanemizde gelişmiş CNC makinelerle ve ekipmanlarla donatılmış olup yıllık kalıp üretim kapasitemiz 1.400 adettir.

Firmamızın kendi AR-GE departmanında geliştirmekte olduğu sistemlerin kalıpları, büyük bir hassasiyetle üretilmekte çeşitli test aşamalarından sonra profil üretimine girilmektedir.

Kesme, delme, bükme, çapak alma, barkodlama gibi işlemlerin yapılabildiği gelişmiş makina parkına sahip konfeksiyon hattımızda, müşterilerimizin talep ettiği her türlü profil işleme işleri yapılmakta ve isteğe uygun olarak paketlenmektedir. İmalatımız da 6063,6060 ,6061,6005, 6082 alaşımli hammaddeden F18 den F31 e kadar çeşitli sertlikte ,su soğutmalı üretim yapabilmekteyiz. Ürettiğimiz tüm ürünler DIN 12020, 12021, 12022 normlarına uygundur.

Alüminyum giydirme cephe, kapı, pencere sektöründe uzman olan firmamızın tesismizdeki üretimini %65'i kapı, pencere, cephe profilleri gibi mimari ürünlerden oluşmaktadır. Mimar ve mühendislerden oluşan 12 kişilik teknik ekibimiz yeni sistemler üretmekte, varolan sistemleri de geliştirmektedir. Tüm sistemlerimiz çeşitli deneyler ve testlerden geçirilmekte sorunsuz ürünü size ulaştırmayı hedefleyen ARGE departmanımız sizlerden gelecek her türlü talebi hızla yerine getirmeye hazırdır. Üretimimizin %67'ini başta Amerika ve Avrupa ülkeleri olmak üzere 28 ülkeye ihraç eden firmamızın yurt içinde de 300'ü aşkın bayii ve kurumsal müşteriye hizmet vermektedir. Şirketimiz birçok ülkede bulunan bağılantı ve ofislerimiz vasıtasıyla hızlı, yerel ve güvenilir hizmet sunmaktadır.

TSE, GOST, GOST-R, CE, CPTP, ISO 9001:2008, QUALONAT, QUALICOAT, IFT ROSENHEIM, ISO 18001, ISO 14001, IATF 16949, EN 15088 gibi bir çok kalite ve standartlar belgesine sahip fabrikamızın yüksek kapasitesi, profil serilerindeki geniş yelpaze ve üretim tecrübesi ile sizlere en iyi profil ve profil sistemlerini sunmaya hazırdır.

ALCAS® ALUMINIUM PROFILE SYSTEMS 270 qualified personnel is working in the factory which is specially built and landed on a total area of 42.000 m2 and a closed area of 36.000 m2 in Çorlu Tekirdağ. We have two extrusion presses in the factory, 2.750 UST 1800 UST and 2540 UST. The annual production capacity is 22.000 tons and all kind of profiles which have width of 10 mm to 310 mm can be produced. Max. Mill Finish surface aged to T6 profile length is 13.6 meters.

Our anodic oxidation plant has got the capacity of making 11.000 tons of profile anodic oxidation annually. The length of our anodic oxidation baths is 8 meters and there the profiles till the length of 7.60 cm net can be made anodic oxidation. In our plant besides the standard 12 micron of coating, the anodic oxidation process from 5 micron to 30 micron depending on the request can be made peculiarly. It is possible to make polished luminous profiles, satin opaque profiles and silver, yellow, bronze, black colored anodic oxidations at the same time in our anodic oxidation plant having the latest technology of Turkey. Our electrostatic paint line has got an oven length of 36 meters and double paint cabins and the profiles until the length of 7.80 cm can be painted in our line in which 180 kinds of RAL colors of 7.000 tons of aluminum profiles can be painted.

All the moulds of our aluminum profile systems are made with the developed CNC machine tools and equipments in our molding room present within the constitution of our factory and our annual capacity of mould production is 1.400 pieces. The molds of the systems which are developed in its own Research & Development department of our firm are produced with great precision and the profile production is started following various test stages. All kinds of profile processing works requested by our

customers are made in our confection line having the developed machinery line where the processes such as cutting, boring, bending, burr removing, bar coding can be made and are packed in conformity with the demand.

We can make water cooled production in various hardness in our production from 18 to 31 of the 6063, 6060, 6061, 6005, 6082 alloyed raw materials. All the products that we produce are in conformity with the norms of DIN 12020, 12021, 12022. 55% of the production in our plant of our firm that is experienced in the aluminum curtain wall, door, window sectors consist of the architectural products such as doors, windows, face wall profiles. Our technical team of 12 persons consisted of Architectures and Engineers produce new systems and change the currently existing systems. All of our systems are being passed through various experiments and tests and our Development & Search department which aims to reach the products without any problem to you, is ready to perform any kind of demand to be received from you rapidly. Our company which exports 70% of its production to 28 countries to the European countries and USA at the first hand also has been giving service to vendors and corporate customers exceeding 300 inside the country. Our company, through our offices in many countries, and the connection fast, local and reliable service provides.

Our factory, which has got a lot of certificates of quality and standards like TSE, GOST, GOST-R, CE, CPTP, ISO, QUALONAT, QUALICOAT, IFT ROSENHEIM, ISO 18001, ISO 14001, IATF 16949, EN 15088 is ready to submit you the best profiles and profile systems along with its high capacity, its wide range at the profile series and the production experience.

Shipping and Packaging / Sevkiyat ve Paketleme

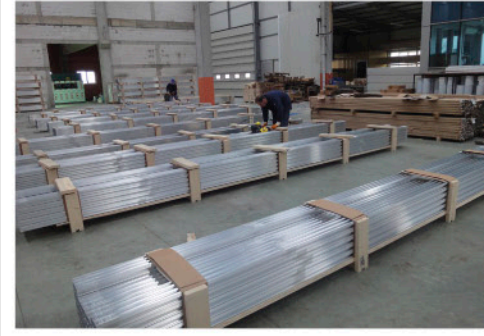

Shipping and Packaging / Sevkiyat ve Paketleme



Die Shop / Kalıphane



Mechanical Processes / Mekanik İşlemler



Electrostatic Paint Line / Elektrostatik Boya Hattı



Anodizing Line / Eloksal Hattı



Die Archive / Kalıp Arşivi



Wood Coating Unit / Ahşap Kaplama Ünitesi

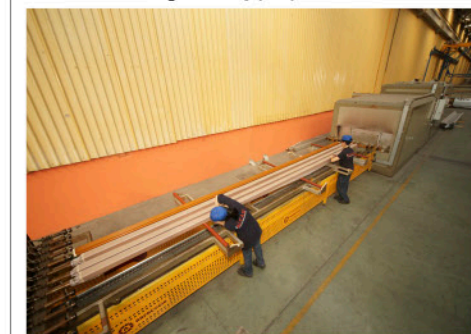

Mechanical Processes / Mekanik İşlemler



Project Name / Proje Adı : Double Tree Otel
 System / Sistem : AF50 C
 City / Şehir : Malatya / TÜRKİYE



ALCAS®

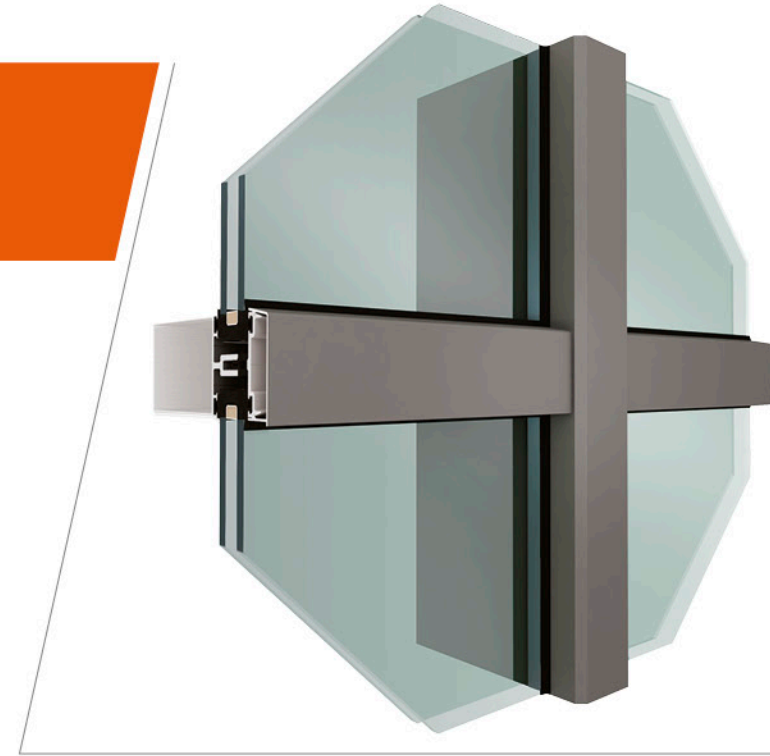

AF50C

Covered Facade System
 Kapaklı Cephe Sistemi

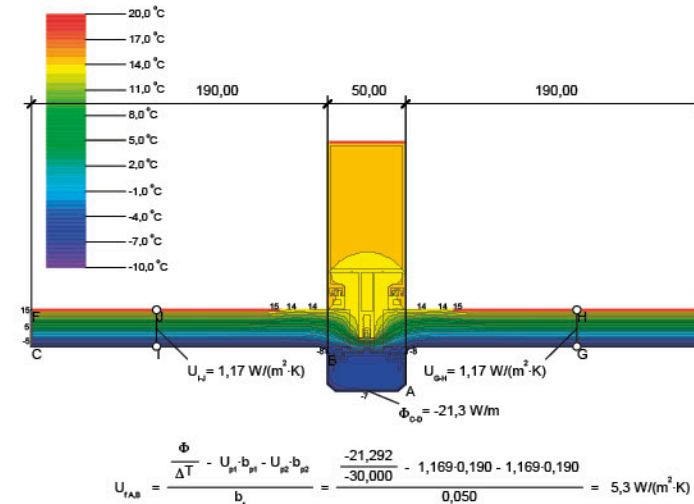

Name	λ[W/(m·K)]	Name	q[W/m²]	θ[C]	η[W/(m²·K)]
Aluminium (35 ekşiyi)	180,000	İstikrar, frame	-10,000	25,000	
EPDM (ethylen propylene diene monomer)	0,200	İstikrar, frame, normal	20,000	7,69291	
Universalized air cavity, Sp=0.9	0,035	İstikrar, frame, reduced	20,000	5,000	
cam panel		Symmetry/Model section	0,000		

Descriptions / Tanımlamalar

		Profile type description	
		Profil tip tanımlamaları	
A	Brand ALCAS®	Marka	ALCAS®
F	System Type Facade	Sistem Tipi	Cephe
50	Series Length	Seri Genişliği	
R	Profile Type	Profil Tipi	
01	Group Location	Gruptaki Yeri	
		M	Mullion Mulyon
		T	Transom Transom
		V	Vent Kanat
		A	Adapter Adaptör
		C	Cover Kapak

Symbols / Semboller

	Corner block assembly with 45° cutting process 45° kesim işlemi köşe takozu ile birleştirme
	Milling process of merging with the vertical connection Kertme işlemi diğk bağlantı ile birleştirme
	Cross-sectional aspect of strength Mukavemet kesit yönü

Taşıyıcı sistemi 2 mm ve 1.8 mm et kalınlığı olan mulyon ve transom profillerine sahip sistemimiz 65 mm' den 200 mm'ye kadar geniş bir ölçü spektrinde üretilmektedir.

ALCAS® AF50 C serisi çok yönlü bir sistemdir. Panel profilleri mulyon profillerine vidayla sabitlenmez erkek ve dişi taşıyıcılara taşınır. Böylece panel deprem anında hareket edebileceğinden kasılmaz, cam kırılması riski en aza indirilir.

Panel profillerimiz oval olduğundan iç mekân estetiği yükselmektedir. Sistemimizde camlar direkt panel profiline değil panelde kanalı bulunan eloksallı tij profiline yapıştırılır. Böylece yine deprem anında cam, panel profiline sabitlenmediği ve esneyebildiği için kırılma çatlama riskini sıfıra indirir.

The carrier system is formed by the mullion (vertical carrier) and transom (horizontal carrier) profiles which has 2 mm and 1.8 mm wall thickness. The width of these profiles is produced between 65 mm to 200 mm in a wide range of measures.

ALCAS® AF50 C series is a versatile system. Panel profiles do not be fixed on mullion profiles by screws; it is loaded by female and male carriers; so that panels are not fully stressed during an earthquake and the glass breakage risk is minimized.

Panel profiles are in oval shape; therefore the internal space aesthetic is better. The glasses are not fastened on the panel profile itself. They are fastened on the anodized stem profiles which are installed in a channel on the panel profile in our system. This prevents glass breakage risk during an earthquake because of very good yielding.

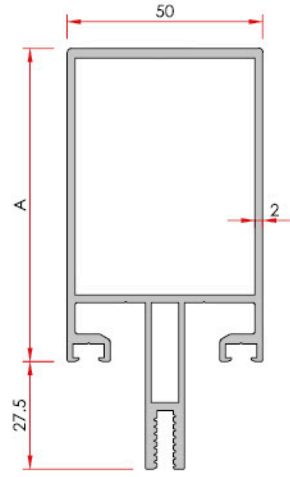

2 mm Mullion Profiles
2 mm Mulyon Profilleri

A	System Code	Profile No	Weight kg/m	Jxx cm ⁴	Jyy cm ⁴	Dilatation Profile Dilatasyon Profili
35 mm	AF50 M 04	1098	1.508	17.0	13.28	---
80 mm	AF50 M 03	1003	2.057	82.89	24.05	1032
100 mm	AF50 M 02	1002	2.337	142.55	29.08	1031
125 mm	AF50 M 01	1001	2.670	246.11	35.25	1030
150 mm	AF50 M 09	1069	3.000	388.23	41.41	1088

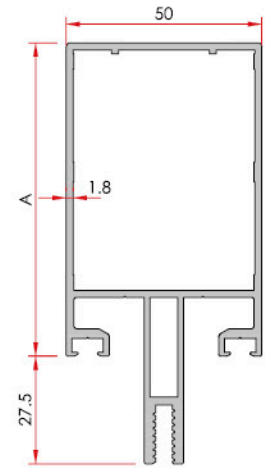

1.8 mm Mullion Profiles
1.8 mm Mulyon Profilleri

A	System Code	Profile No	Weight kg/m	Jxx cm ⁴	Jyy cm ⁴	Dilatation Profile Dilatasyon Profili
65 mm	AF50 M 1804	1004	1.779	48.17	19.48	---
80 mm	AF50 M 1803	1084	1.902	74.26	22.95	1032
100 mm	AF50 M 1802	1083	2.103	121.12	26.6	1031
125 mm	AF50 M 1801	1082	2.352	201.81	31.86	1030

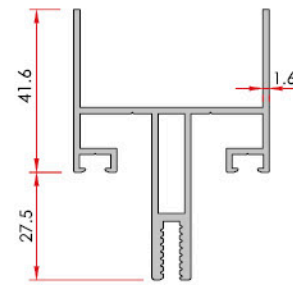

Mullion
Mulyon

System Code	Profile No	Weight kg
AF50 mm 12	1092	1.188

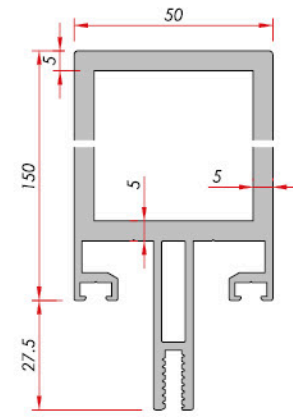

Mullion
Mulyon

System Code	Profile No	Weight kg	
AF50 M 20	0990	5.604	
Jxx cm ⁴	574.9	Jyy cm ⁴	79.4

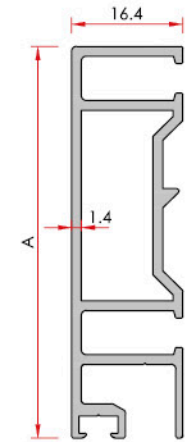

2 mm Half Mullion
2 mm Yarım Mulyon

A	System Code	Profile No	Weight kg/m	Jxx cm ⁴	Jyy cm ⁴	Dilatation Profile Dilatasyon Profili
80 mm	AF50 M 07	1014	1.299	29.52	3.21	1027
100 mm	AF50 M 06	1013	1.515	55.41	3.77	1028
125 mm	AF50 M 05	1012	1.787	103.65	4.47	1029

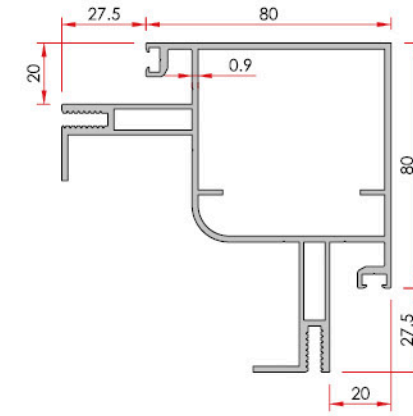

90° Corner Profile
90° Köşe Profili

System Code	Profile No	Weight kg/m	Jxx cm ⁴	Jyy cm ⁴	Dilatation Profile Dilatasyon Profili
AF50 M 10	1104	2.850	112	114	1032

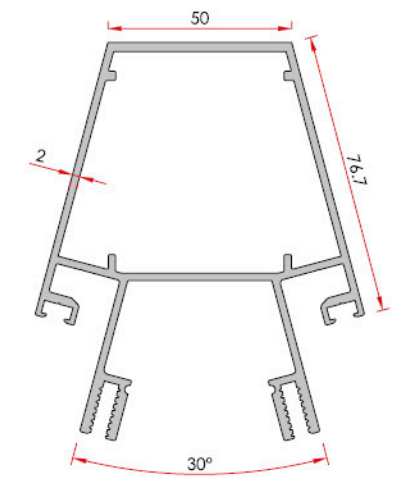
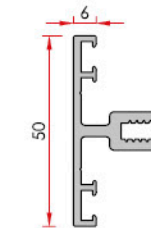
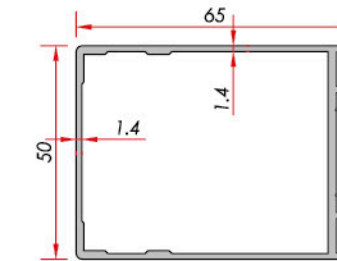
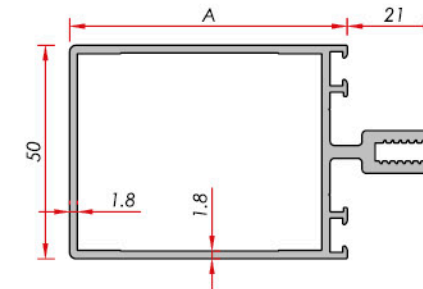

135° Corner Profile
135° Köşe Profili

System Code	Profile No	Weight kg/m	Jxx cm ⁴	Jyy cm ⁴	Dilatation Profile Dilatasyon Profili
AF50 M 08	1067	2.642	104.5	77.5	1032

Transom Profiles
Transom Profilleri

A	System Code	Profile No	Weight kg/m	Jxx cm ⁴	Jyy cm ⁴	Dilatation Profile Dilatasyon Profili
35 mm	AF50 T 04	1008	1.246	13.00	11.36	25 mm
65 mm	AF50 T 03	1007	1.539	43.37	17.63	55 mm
80 mm	AF50 T 02	1006	1.675	67.60	20.77	70 mm
100 mm	AF50 T 01	1005	1.876	110.73	27.95	90 mm
105 mm	AF50 T 06	1115	1.773	114.7	23.6	95 mm
128 mm	AF50 T 07	1123	2.148	195.95	30.7	110 mm
156 mm	AF50 T 09	0989	2.579	324.4	39.5	110 mm

Hidden Transom
Gizli Transom

System Code	Profile No	Weight kg/m	Jxx cm ⁴	Jyy cm ⁴	Dilatation Profile Dilatasyon Profili
AF50 T 08	1116	1.012	22.76	14.88	55 mm

Transom
Transom

System Code	Profile No	Weight kg/mt
AF50 T 05	1009	0.718

ALCAS®



» **GENERAL PROFILES & ACCESSORIES**
GENEL PROFİLLER VE AKSESUARLAR

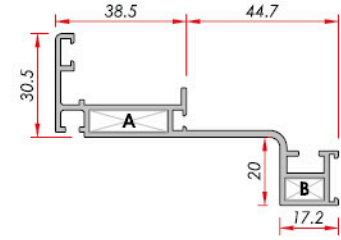

Hidden Wing Frame
Gizli Kanat Kasa Panel

System Code	Profile No	Weight kg
AF50 V 03	1022	1.008
A	AKB-1097-22	
B	AKB-1097-10	

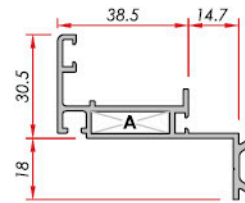

Hidden Wing Frame
Gizli Kanat Kasa

System Code	Profile No	Weight kg
AF50 V 09	1096	0.706
A	AKB-1097 - 22	
B	---	

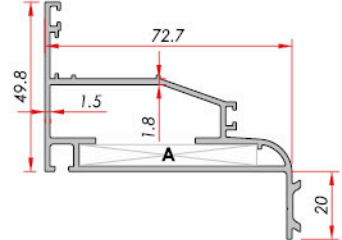

Hidden Wing Frame
Gizli Kanat Kasa Panel

System Code	Profile No	Weight kg
AF50 V 21	1171	1.201
A	AKB-1097-51	
B	---	

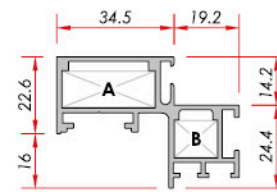

Bonding Lath Narrow Glass Panel (Vent)
Bonding Çıtalı Dar Cam Paneli (Kanat)

System Code	Profile No	Weight kg
AF50 V 16	1049	0.883
A	AKB-1034-26	
B	AKB-1034-12	

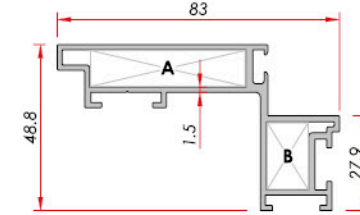

Bonding Lath Glass Panel (Sash)
Bonding Çıtalı Cam Paneli (Kanat)

System Code	Profile No	Weight kg
AF50 V 20	1172	1.235
A	AKB-1034-45	
B	AKB-1730-11	

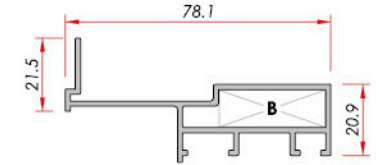

Composite Panel
Kompoze Panel

System Code	Profile No	Weight kg
AF50 V 13	1149	0.825
A	---	
B	AKB-1034-30	

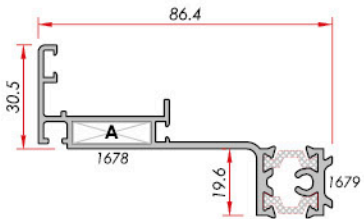

Hidden Wing Frame
Gizli Kanat Kasa Panel

System Code	Profile No	Weight kg
AF50 V 22	1679-1678	1.303
A	AKB-1097 - 22	
B	---	

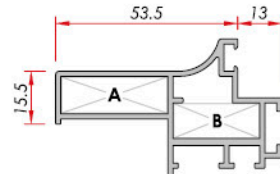

Glazing Panel (Vent)
Cam Paneli (Kanat)

System Code	Profile No	Weight kg
AF50 V 01	1010	0.998
A	AKB-1034-30	
B	AKB-1034-24	

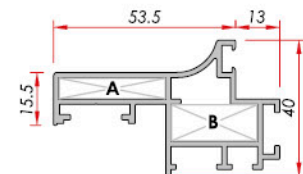

Glazing Panel (Vent)
Cam Paneli (Kanat)

System Code	Profile No	Weight kg
AF50 V 14	1150	1.020
A	AKB-1097-30	
B	AKB-1034-24	

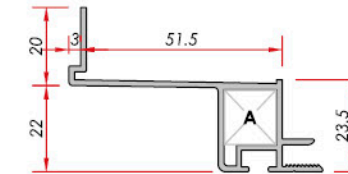

Composite Panel
Kompoze Panel

System Code	Profile No	Weight kg
AF50 V 18	1197	0.635
A	AKB-1328-12	
B	---	

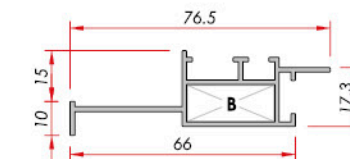

Composite Panel
Kompoze Panel

System Code	Profile No	Weight kg
AF50 V 08	1087	0.635
A	---	
B	AKB-1034-24	

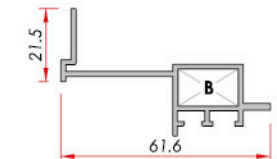

Composite Panel
Kompoze Panel

System Code	Profile No	Weight kg
AF50 V 11	1121	0.583
A	---	
B	AKB-1034-16	

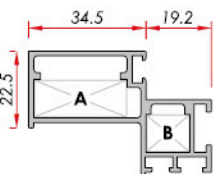

Glazing Panel (Vent)
Cam Paneli (Kanat)

System Code	Profile No	Weight kg
AF50 V 12	1131	0.805
A	AKB-1034-26	
B	AKB-1034-12	

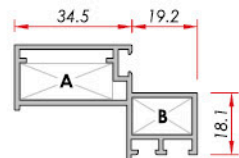

Glazing Panel (Vent)
Cam Paneli (Kanat)

System Code	Profile No	Weight kg
AF50 V 07	1085	0.702
A	AKB-1034-26	
B	AKB-1034-16	

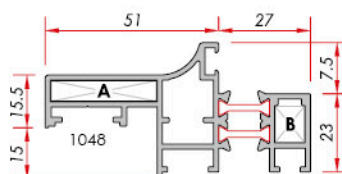

Narrow Glass Panel (Vent)
Dar Cam Paneli (Kanat)

System Code	Profile No	Weight kg
AF50 V 19	1024-1048	1.382
A	AKB-1097-30	
B	AKB-1034-8	

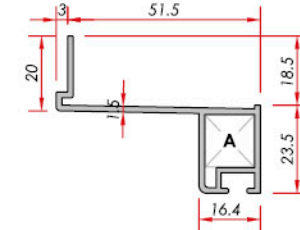

Single Glass Panel
Tek Cam Paneli

System Code	Profile No	Weight kg
AF50 V 17	1196	0.570
A	AKB-1328-12	
B	---	

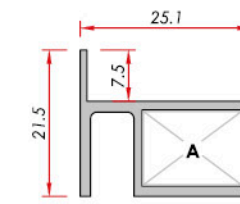

Single Glass Panel
Tek Cam Paneli

System Code	Profile No	Weight kg
AF50 V 10	1109	0.309
A	AKB-1034-14	
B	---	

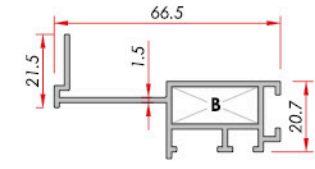

Spandrel Panel
Spandrel Paneli

System Code	Profile No	Weight kg
AF50 V 02	1045	0.723
A	---	
B	AKB-1034 - 24	

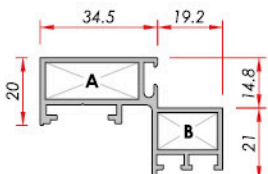

Narrow Glass Panel (Vent)
Dar Cam Paneli (Kanat)

System Code	Profile No	Weight kg
AF50 V 15	1151	0.772
A	AKB-1034-26	
B	AKB-1034-16	

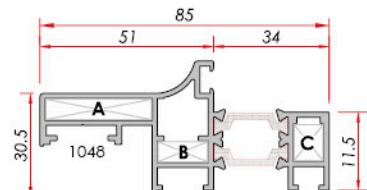

Insulated Glazing Panel (Sash)
Yalıtımlı Cam Paneli (Kanat)

System Code	Profile No	Weight kg
AF50 V 23	1024-1048	1.457
A	AKB-1097-30	
B	AKB-1097-14	
C	AKB-1034-8	

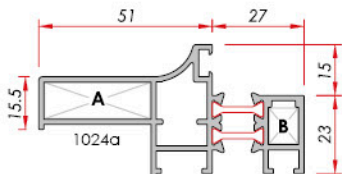

Insulated Glazing Panel (Sash)
Yalıtımlı Cam Paneli (Kanat)

System Code	Profile No	Weight kg
AF50 V 05	1024-1024a	1.210
A	AKB-1034 - 30	
B	AKB-1097 - 8	

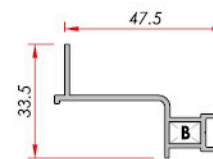

Spandrel Panel
Spandrel Paneli

System Code	Profile No	Weight kg
AF50 V 04	1023	0.408
A	---	
B	AKB-1097 - 8	

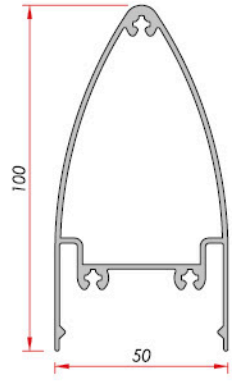

Cover
Badem Kapak

System Code	Profile No	Weight kg
AF50 C 01	1015	1.365

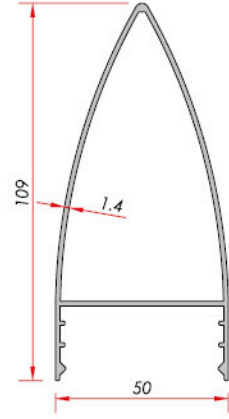

Cover
Badem Kapak

System Code	Profile No	Weight kg
AF50 C 10	1184	1.100

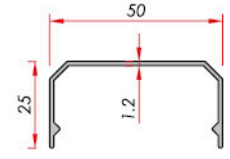

Cover
Dikey Kapak

System Code	Profile No	Weight kg
AF50 C 02	1016	0.330

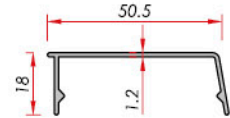

Cover
Yatay Kapak

System Code	Profile No	Weight kg
AF50 C 03	1017	0.294

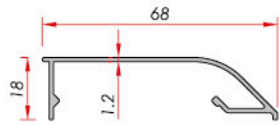

Skylight Cover
Skylight Kapak

System Code	Profile No	Weight kg
AF50 C 04	1018	0.385

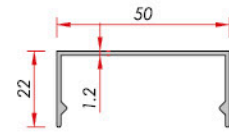

Cover
Dikey Kapak

System Code	Profile No	Weight kg
AF50 C 07	1046	0.326

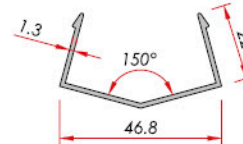

Cover
Kapak

System Code	Profile No	Weight kg
AF50 C 09	1068	0.333

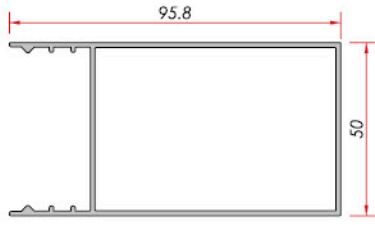

Cover
Dikey Kapak

System Code	Profile No	Weight kg/m
AF50 C 12	1173	1.107

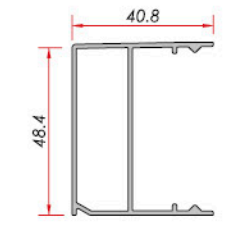

Cover
Yatay Kapak

System Code	Profile No	Weight kg/m
AF50 C 13	1174	0.615

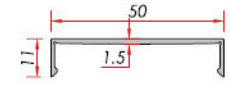

Cover
Dikey Kapak

System Code	Profile No	Weight kg/m
AF50 C 15	1175	0.260

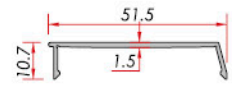

Cover
Yatay Kapak

System Code	Profile No	Weight kg
AW50 C 16	1177	0.255

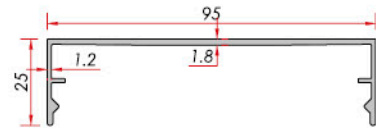

Cover
Dikey Kapak

System Code	Profile No	Weight kg
AF50 C 18	1178	0.670

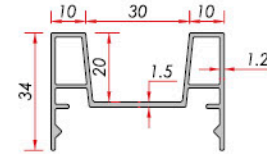

Cover
Fugalı Kapak

System Code	Profile No	Weight kg
AF50 C 19	2057	0.630

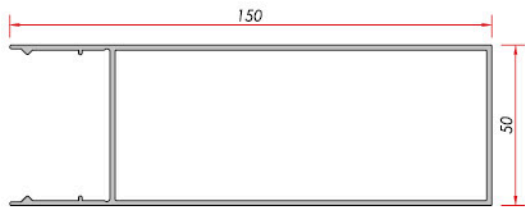

Cover
Kapak

System Code	Profile No	Weight kg
AW50 C 20	1199	1.768

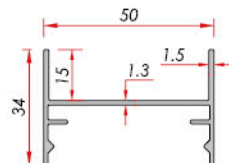

Cover
Fugalı Kapak

System Code	Profile No	Weight kg
AW50 C 21	1879	0.485

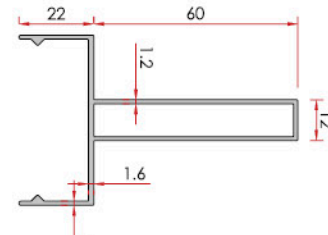

Cover
Dikey Kapak

System Code	Profile No	Weight kg
AW50 C 28	5102	0.814

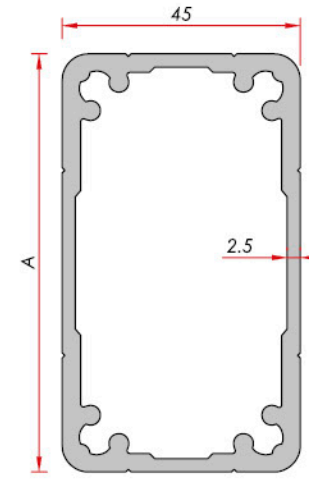

2 mm Mullion Dilatation
2 mm Mulyon Dilatasyon

A	System Code	Profile No	Weight kg/mt	Jxx cm4	Jyy cm4	Mullion Profile Mulyon Profili
59.5 mm	1032	1032	1.905	34.5	21.0	AF50 M 03 AF50 M 1803 AF50 EM 04 AF50 MH 03
79 mm	1031	1031	2.238	70.9	26.4	AF50 M 02 AF50 M 1802 AF50 MH 04 AF50 EM 03
103.5 mm	1030	1030	2.508	133.8	31.1	AF50 M 01 AF50 M 1801 AF50 EM 02 AF50 MH 01
128 mm	1088	1088	2.851	226.8	36.6	AF50 M 09 AF50 EM 01 AF50 MH 05

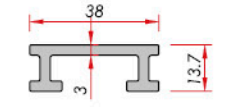

Half Mullion Dilatation
Yarım Mulyon Dilatasyon

System Code	Profile No	Weight kg
1027	1027	0.586

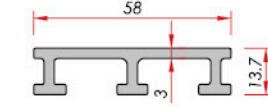

Half Mullion Dilatation
Yarım Mulyon Dilatasyon

System Code	Profile No	Weight kg
1028	1028	0.889

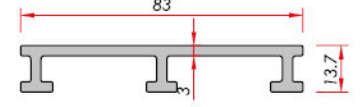

Half Mullion Dilatation
Yarım Mulyon Dilatasyon

System Code	Profile No	Weight kg
1029	1029	1.086

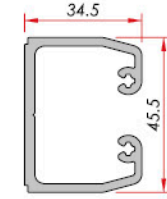

Mullion Dilatation
Mulyon Dilatasyon

System Code	Profile No	Weight kg
1033	1033	1.059

Cutting Size Kesim Ölçüsü	25 mm	40 mm	55 mm	70 mm	90 mm	95 mm	100 mm	110 mm	145 mm
Transom Profile Transom Profili	AF 50 T 04 AF50 TH 05	AF50 LM 02 AF50 M 1804	AF50 T 03 AF50 T 08 AF50 ET 04 AF50 TH 01 AF50 M 1803	AF50 T 02 AF50 ET 03 AF50 TH 02 AF50 LM 01 AF50 M 1802	AF50 T 01 AF50 ET 02 AF50 TH 03	AF50 T 06	AF50 M 1801	AF50 T 07 AF50 ET 01 AF50 TH 04 AF50 M 1801	AF50 T 09

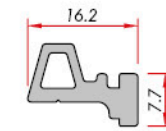

Panel Assembling Clips
Kaset montaj Klipsi

System Code	Profile No	Weight kg
1282	1282	0.215

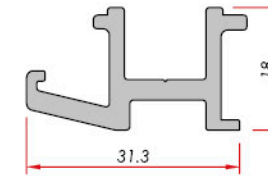

Panel Assembling Wedge
Kaset Montaj Takozu

System Code	Profile No	Weight kg
4417	4417	0.525

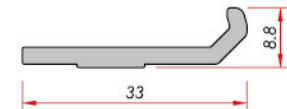

Glass Wedge
Cam Takozu

System Code	Profile No	Weight kg
1026	1026	0.269

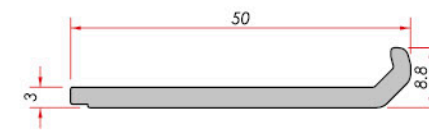

Glass Wedge
Cam Takozu

System Code	Profile No	Weight kg
1680	1680	0.442

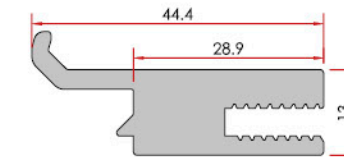

Glass Wedge
Cam Takozu

System Code	Profile No	Weight kg
0991		1.027

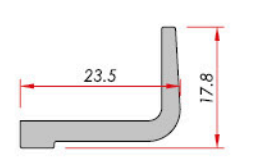

Glass Wedge
Cam Takozu

System Code	Profile No	Weight kg
1101	1101	0.284

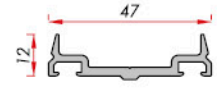

Cover
Baskı Kapak

System Code	Profile No	Weight kg
AF50 C 05	1019	0.438

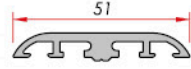

Skylight Cover
Skylight Baskı Kapak

System Code	Profile No	Weight kg
AF50 C 06	1020	0.531

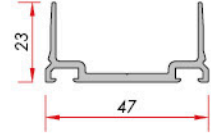

Cover
Baskı Kapak

System Code	Profile No	Weight kg
AF50 C 11	1183	0.516

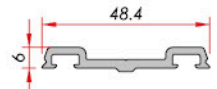

Cover
Baskı Kapak

System Code	Profile No	Weight kg/m
AF50 C 14	1176	0.400

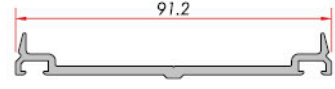

Cover
Baskı Kapak

System Code	Profile No	Weight kg/m
AF50 C 17	1179	0.747

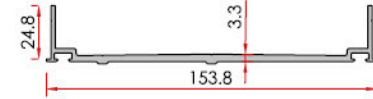

Cover
Baskı Kapak

System Code	Profile No	Weight kg/m
AF50 C 22	1180	1.571

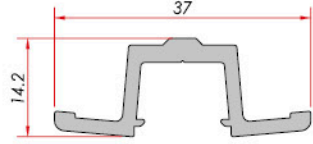

Cover
Derz Kapak Profili

System Code	Profile No	Weight kg/m
AF50 A 05	1025	0.365

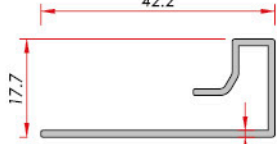

Dilatation Profile
Dilatasyon Kapak

System Code	Profile No	Weight kg
AF50 A 02	1042	0.265

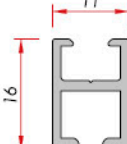

Single Glass Bead
Tek Cam Çıtası

System Code	Profile No	Weight kg
AF50 A 03	1021	0.184

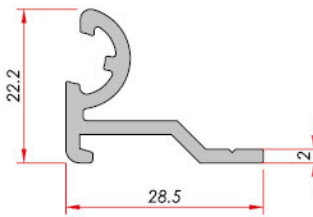

Corner
Köşe Dönüş Dış

System Code	Profile No	Weight kg
AF50 A 06	1040	0.347

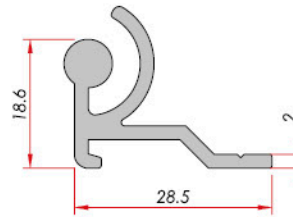

Corner
Köşe Dönüş İç

System Code	Profile No	Weight kg
AF50 A 07	1041	0.350

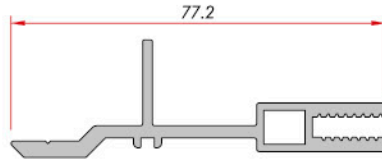

Half Mullion Adapter
Yarım Mulyon Adaptörü

System Code	Profile No	Weight kg
AF50 A 01	1011	1.030

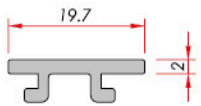

Bonding Bead
Bonding Çıtası

System Code	Profile No	Weight kg/m
AF50 A 08	1043	0.154

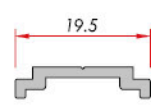

Stem
Tij

System Code	Profile No	Weight kg
AF50 A 10	1375	0.126

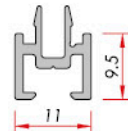

Single Glass Bead
Tek Cam Çıtası

System Code	Profile No	Weight kg
AF50 A 12	1106	0.141

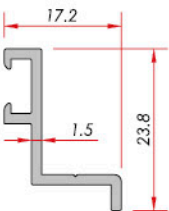

Adaptor
Adaptör

System Code	Profile No	Weight kg/m
AF50 A 17	1182	0.182

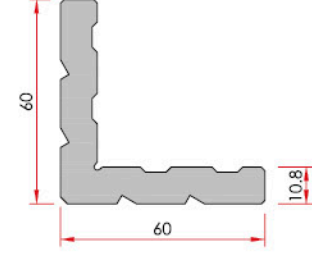

Corner Cleat
Köşe Takozu

System Code	Profile No	Weight kg
1034	1034	2.967

Accessory Code	Profile Code	Cutting Size
AKB-1034-8.5	AF50 V 05 (1024) AF50 V 19 (1024) AF50 V 23 (1024)	8.5 mm

Accessory Code	Profile Code	Cutting Size
AKB-1034-12.5	AF50 V 16 (1049) AF50 V 12 (1131)	12.5 mm

Accessory Code	Profile Code	Cutting Size
AKB-1034-14.4	AF50 V 10 (1109)	14.4 mm

Accessory Code	Profile Code	Cutting Size
AKB-1034-17.2	AF50 V 15 (1151) AF50 V 07 (1085) AF50 V 11 (1121)	17.2 mm

Accessory Code	Profile Code	Cutting Size
AKB-1034-25	AF50 V 01 (1010) AF50 V 02 (1045) AF50 V 08 (1087) AF50 V 14 (1150)	25 mm

Accessory Code	Profile Code	Cutting Size
AKB-1034-27	AF50 V 15 (1151) AF50 V 16 (1049) AF50 V 07 (1085) AF50 V 12 (1131)	27 mm

Accessory Code	Profile Code	Cutting Size
AKB-1034-31	AF50 V 01 (1010) AF50 V 05 (1024) AF50 V 13 (1149)	31 mm

Accessory Code	Profile Code	Cutting Size
AKB-1034-45.5	AF50 V 20 (1172)	45.5 mm

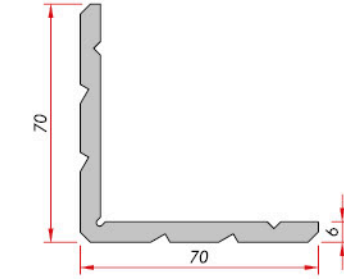

Corner Cleat
Köşe Takozu

System Code	Profile No	Weight kg
1097	1097	2.032

Accessory Code	Profile Code	Cutting Size
AKB-1097-9	AF50 V 04 (1023)	9 mm

Accessory Code	Profile Code	Cutting Size
AKB-1097-11	AF50 V 03 (1022)	11 mm

Accessory Code	Profile Code	Cutting Size
AKB-1097-14.5	AF50 V 01 (1010) AF50 V 23 (1048)	14.5 mm

Accessory Code	Profile Code	Cutting Size
AKB-1097-22.5	AF50 V 03 (1022) AF50 V 09 (1096) AF50 V 22 (1678)	22.5 mm

Accessory Code	Profile Code	Cutting Size
AKB-1097-31	AF50 V 14 (1150) AF50 V 19 (1048)	31 mm

Accessory Code	Profile Code	Cutting Size
AKB-1097-52	AF50 V 23 (1048) AF50 V 21 (1171)	52 mm

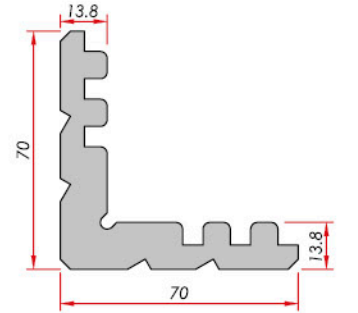

Corner Cleat
Köşe Takozu

System Code	Profile No	Weight kg
1328	1328	3.865

System Code	Profile No	Cutting Size
AKB-1028-13	AF50 V 17 (1196) AF50 V 18 (1197)	13 mm

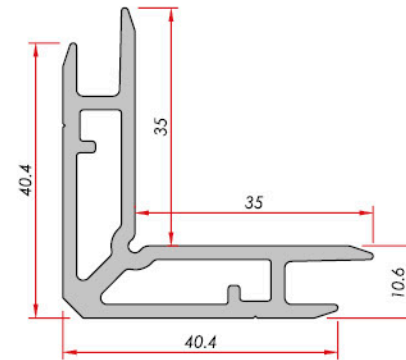

Corner Cleat
Köşe Takozu

System Code	Profile No	Weight kg
1297	1297	1.031

System Code	Profile No	Cutting Size
AKB-1034-12.5	AF50 V 16 (1049)	12.5 mm

System Code	Profile No	Cutting Size
AKB-1034-17.2	AF50 V 15 (1151) AF50 V 11 (1121)	17.2 mm

System Code	Profile No	Cutting Size
AKB-1034-27	AF50 V 15 (1151) AF50 V 16 (1049)	27 mm

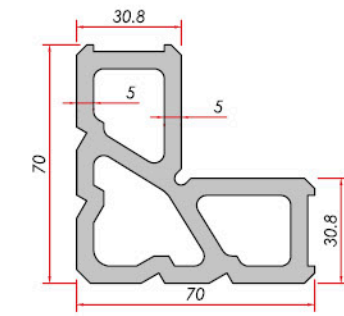

Corner Cleat
Köşe Takozu



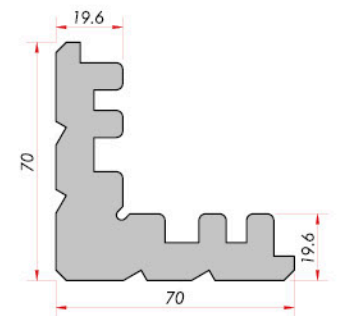

System Code	Profile No	Weight kg
1329	1329	4.388





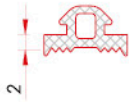
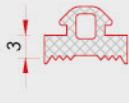
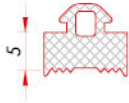
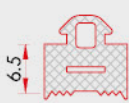

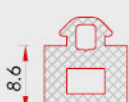
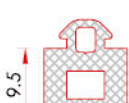

Corner Cleat
Köşe Takozu

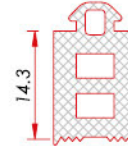
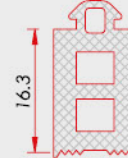
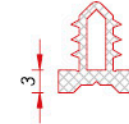
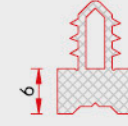
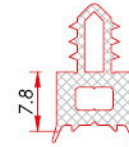
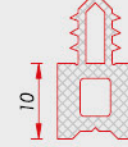
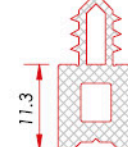
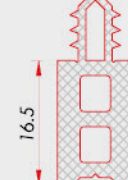

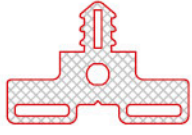
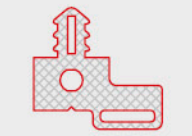
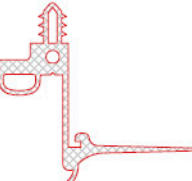



System Code	Profile No	Weight kg
1730	1730	5.531

System Code	Profile No	Cutting Size
AKB-1730-12	AKB-1730-12	12 mm

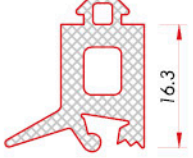
CODE / KOD	ACCESSORIES / AKSESUAR	DESCRIPTION / AÇIKLAMA
01-1002		325-350 mt/Koli
01-1003		250 mt/Koli
01-1005		200 mt/Koli
01-1007		165 mt/Koli
01-1008		120 mt/Koli
01-1009		130 mt/Koli
01-1010		120 mt/Koli
01-1012		117 mt/Koli

CODE / KOD	ACCESSORIES / AKSESUAR	DESCRIPTION / AÇIKLAMA
01-1014		83 mt/Koli
01-1016		75 mt/Koli
01-1103		230 mt/Koli
01-1106		145 mt/Koli
01-1108		135 mt/Koli
01-1110		125 mt/Koli
01-1111		100 mt/Koli
01-1117		75 mt/Koli

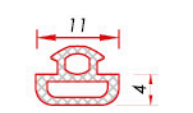
CODE / KOD	ACCESSORIES / AKSESUAR	DESCRIPTION / AÇIKLAMA
01-1120		70 mt/Koli
01-1121		85 mt/Koli
01-1122		58 mt/Koli
01-1203		215 mt/Koli
01-1211		95 mt/Koli
01-1215		130 mt/Koli
01-1258		125 mt/Koli
01-1264		80 mt/Koli

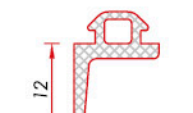
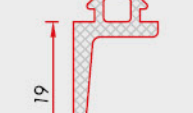
CODE / KOD	ACCESSORIES / AKSESUAR	DESCRIPTION / AÇIKLAMA
01-1266		75 mt/Koli
01-1303		230 mt/Koli
01-1304		150 mt/Koli
01-1314		150 mt/Koli
01-1404		230-270 mt/Koli
01-1410		115 mt/Koli
01-1412		215 mt/Koli
01-1419		175 mt/Koli

CODE / KOD	ACCESSORIES / AKSESUAR	DESCRIPTION / AÇIKLAMA
01-1431		150 mt/Koli
01-1450		270 mt/Koli
01-1451		450 mt/Koli
01-1452		250 mt/Koli
01-1453		150 mt/Koli
01-1454		175 mt/Koli
01-1457		365 mt/Koli
01-1460		115 mt/Koli
01-1503		155 mt/Koli

CODE / KOD	ACCESSORIES / AKSESUAR	DESCRIPTION / AÇIKLAMA
01-1505		115 mt/Koli
01-1507		95 mt/Koli
01-1510		100 mt/Koli
01-1512		75 mt/Koli
01-1514		65 mt/Koli
01-1605		90 mt/Koli
01-1615		95 mt/Koli
01-1621		65 mt/Koli
01-2033		375 mt/Koli

CODE / KOD	ACCESSORIES / AKSESUAR	DESCRIPTION / AÇIKLAMA
02-1001		50 mt/Koli
02-1002		100 mt/Koli
02-1101		50 mt/Koli
03-1002		Transom Insulation Gasket Transom Yalıtım Contası 1 Pack Contains 100 Pieces 1 Pakette 100 Adet
03-1003		Side Coverings Badem Kapak Yan Kapamaları 1 Pack Contains 100 Pieces 1 Pakette 100 Adet
03-1004		Side Coverings Badem Kapak Yan Kapamaları 1 Pack Contains 100 Pieces 1 Pakette 100 Adet
03-1065		65mm Transom Dilatation Gasket 65 mm Transom Genleşme Contası 1 Pack Contains 50 Pieces 1 Pakette 50 Adet
03-1080		80 mm Transom Dilatation Gasket 80 mm Transom Genleşme Contası 1 Pack Contains 50 Pieces 1 Pakette 50 Adet

CODE / KOD	ACCESSORIES / AKSESUAR	DESCRIPTION / AÇIKLAMA																												
03-1100		100 mm Transom Dilatation Gasket 100 mm Transom Genleşme Contası 1 Pack Contains 50 Pieces 1 Pakette 50 Adet																												
03-1128		128 mm Transom Dilatation Gasket 128 mm Transom Genleşme Contası 1 Pack Contains 50 Pieces 1 Pakette 50 Adet																												
03-1244		244 mm Transom Dilatation Gasket 244 mm Transom Genleşme Contası 1 Pack Contains 50 Pieces 1 Pakette 50 Adet																												
03-2010		12 mm Installation cap 12 mm Montaj Tapası 1 Pack Contains 100 Pieces 1 Pakette 100 Adet																												
03-2082 03-2084 03-2202 03-2203 03-2205 03-2252 03-2253 03-2255 03-2282 03-2283 03-2285		<table border="1"> <thead> <tr> <th>A</th> <th>B</th> <th>A</th> <th>B</th> </tr> </thead> <tbody> <tr> <td>2</td> <td>8</td> <td>3</td> <td>25</td> </tr> <tr> <td>4</td> <td>8</td> <td>5</td> <td>25</td> </tr> <tr> <td>2</td> <td>20</td> <td>2</td> <td>28</td> </tr> <tr> <td>3</td> <td>20</td> <td>3</td> <td>28</td> </tr> <tr> <td>5</td> <td>20</td> <td>5</td> <td>28</td> </tr> <tr> <td>2</td> <td>25</td> <td></td> <td></td> </tr> </tbody> </table>	A	B	A	B	2	8	3	25	4	8	5	25	2	20	2	28	3	20	3	28	5	20	5	28	2	25		
A	B	A	B																											
2	8	3	25																											
4	8	5	25																											
2	20	2	28																											
3	20	3	28																											
5	20	5	28																											
2	25																													
03-2310		Gutter Çörten 1 Pack Contains 25 Pieces 1 Pakette 25 Adet																												
04-1001		Concealed Vent PVC Frame Exterior Gizli Kanat Kasa Plastiği Dış Order Length: 3 mt Sipariş Boyu 3 mt																												
		Concealed Vent PVC Frame Exterior Gizli Kanat Kasa Plastiği Dış Order Length: 3 mt Sipariş Boyu 3 mt																												

CODE / KOD	ACCESSORIES / AKSESUAR	DESCRIPTION / AÇIKLAMA
04-1003		Filling Silicone Strengthening (TPV) Dolgu Silikonu Besleme Fitiği (TPV)
04-1005		Mulyon-Transom Insulation PVC Mulyon-Transom Yalıtım Plastiği Order Length 3 mt Sipariş Boyu 3 mt
04-1011		Mulyon PVC Heat Insulation Mulyon Isı Yalıtım Plastiği Order Length 3 mt Sipariş Boyu 3 mt
04-1019		Mulyon PVC Heat Insulation Mulyon Isı Yalıtım Plastiği Order Length 3 mt Sipariş Boyu 3 mt
04-1029		Mulyon PVC Heat Insulation Mulyon Isı Yalıtım Plastiği Order Length 3 mt Sipariş Boyu 3 mt
05-1001		(T) Connection (T) Bağlantı 1 Pack Contains 50 Pieces 1 Pakette 50 Adet
05-1002		Espagnolette Pin Counter İspanyolet Pim Karşılığı 1 Pack Contains 50 Pieces 1 Pakette 50 Adet
05-1003		Adet

CODE / KOD	ACCESSORIES / AKSESUAR	DESCRIPTION / AÇIKLAMA
06-1001		Cassette Side Holder Kaset Yan Tutucu 1 Pack Contains 100 Pieces 1 Pakette 100 Adet
06-1002		Cassette Side Holder Kaset Yan Tutucu 1 Pack Contains 100 Pieces 1 Pakette 100 Adet
06-1003		AF50 V01,02,05,08,13 Cassette Top Holder Kaset Üst Tutucu 1 Pack Contains 100 Pieces 1 Pakette 100 Adet
06-1004		AF50 V07,11,12 Cassette Top Holder Kaset Üst Tutucu 1 Pack Contains 100 Pieces 1 Pakette 100 Adet
06-1005		AF50 V07,11,12,15,16 Cassette Holder Kaset Tutucu 1 Pack Contains 100 Pieces 1 Pakette 100 Adet
06-1007		AF50 V07,11,12,15,16 Cassette Wedge Kaset Takozu 1 Pack Contains 50 Pieces 1 Pakette 50 Adet
06-1008		AF50 V07,11,12,15,16 Cassette Wedge Kaset Takozu 1 Pack Contains 50 Pieces 1 Pakette 50 Adet
06-1009		Surface 20 mic. Black Anodized Yüzey 20 mic. Siyah Eloksal 1 Pack Contains 50 Pieces 1 Pakette 50 Adet

CODE / KOD	ACCESSORIES / AKSESUAR	DESCRIPTION / AÇIKLAMA
06-1010		Condense Channel -Dilatation Insulation Profile Kondens Kanalı Dilatasyon Yalıtım Profili 1 Pack Contains 100 Pieces 1 Pakette 100 Adet
06-1011		Condense Channel -Dilatation Insulation Profile Kondens Kanalı Dilatasyon Yalıtım Profili 1 Pack Contains 100 Pieces 1 Pakette 100 Adet
06-1012		Assembling Clips Montaj Klipsi 1 Pack Contains 100 Pieces 1 Pakette 100 Adet
06-1013		External Corner Mounting Clips Dış Köşe Montaj Klipsi 1 Pack Contains 100 Pieces 1 Pakette 100 Adet
06-1014		Assembling Clips Internal Corner İç Köşe Montaj Klipsi 1 Pack Contains 100 Pieces 1 Pakette 100 Adet
06-1015		Assembling Angle Clips Açılı Montaj Klipsi 1 Pack Contains 100 Pieces 1 Pakette 100 Adet
06-1133		Aluminium Glazing Cleat Aluminyum Cam Takozu 1 Pack Contains 50 Pieces 1 Pakette 50 Adet
06-1150		Aluminium Glazing Cleat Aluminyum Cam Takozu 1 Pack Contains 50 Pieces 1 Pakette 50 Adet

CODE / KOD	ACCESSORIES / AKSESUAR	DESCRIPTION / AÇIKLAMA
06-1227		Aluminium Glazing Cleat Aluminyum Cam Takozu 1 Pack Contains 50 Pieces 1 Pakette 50 Adet
06-1345		Aluminium Glazing Cleat Aluminyum Cam Takozu 1 Pack Contains 50 Pieces 1 Pakette 50 Adet
09-1530 09-1531 09-1532 09-1533 09-1534		One Way Axial Handle Tek Yöne Eksenel Kol Anodizing / Nat. Eloksal White / Beyaz Brown / Kahverengi Raw / Ham Special / Özel Renk
09-1540 09-1541 09-1542 09-1543 09-1544		Dual Way Axial Handle Çift Yöne Eksenel Kol Anodizing / Nat. Eloksal White / Beyaz Brown / Kahverengi Raw / Ham Special / Özel Renk
09-2700		Espagnolette Pin İspanyolet Pimi 1 Pack Contains 50 Pieces 1 Pakette 50 Adet
09-2701		Corner Transfer Espagnolette İspanyolet Köşe Aktarma 1 Pack Contains 30 Pieces 1 Pakette 30 Adet
10-1010		Anchorage Guide Tube Ankraj Klavuz Borusu 1 Pack Contains 100 Pieces 1 Pakette 100 Adet
10-1015		Rockwool Of 80 Pins 80 lik Taş Yünü Çivisi 1 Pack Contains 100 Pieces 1 Pakette 100 Adet

CODE / KOD	ACCESSORIES / AKSESUAR	DESCRIPTION / AÇIKLAMA
09-3000		Concealed Vent Facade Gizli Kanat Cephe Makası Takım (1 Takımda sağ ve sol olmak üzere 2 adet makas vardır.) SPT22 567 mm 1090-1500 mm 75 Kg
09-3001		Concealed Vent Facade Gizli Kanat Cephe Makası Takım (1 Takımda sağ ve sol olmak üzere 2 adet makas vardır.) SPT22W 567 mm 1090-1500 mm 75 Kg
09-3002		Concealed Vent Facade Gizli Kanat Cephe Makası Takım (1 Takımda sağ ve sol olmak üzere 2 adet makas vardır.) SPT26 682 mm 1090-2500 mm 180 Kg
09-3003		Concealed Vent Facade Gizli Kanat Cephe Makası Takım (1 Takımda sağ ve sol olmak üzere 2 adet makas vardır.) SPTH16 415 mm 1090-1500 mm 75 Kg
09-3004		Concealed Vent Facade Gizli Kanat Cephe Makası Takım (1 Takımda sağ ve sol olmak üzere 2 adet makas vardır.) SPT16 415 mm 787-1090 mm 55 Kg
09-3005		Concealed Vent Facade Gizli Kanat Cephe Makası Takım (1 Takımda sağ ve sol olmak üzere 2 adet makas vardır.) SPT12 313 mm 635-787 mm 45 Kg

CODE / KOD	ACCESSORIES / AKSESUAR	DESCRIPTION / AÇIKLAMA
09-3010L 09-3010R		Hinges Code Makas Kodu PX0350 Max. Vent Weight (Kg) Max. Kanat Ağırlığı 100 Min. Vent Height (mm) Min. Kanat Yüksekliği 350 Max. Vent Height (mm) Max. Kanat Yüksekliği 750 Max. Manual Opening Max. Manuel Açılım 150 Max. Motorised Opening Max. Motorlu Açılım 180 Manual Limit Stop Manuel Limit Stoplayıcı CB700
09-3011L 09-3011R		Hinges Code Makas Kodu PX0450 Max. Vent Weight (Kg) Max. Kanat Ağırlığı 100 Min. Vent Height (mm) Min. Kanat Yüksekliği 450 Max. Vent Height (mm) Max. Kanat Yüksekliği 1000 Max. Manual Opening Max. Manuel Açılım 150 Max. Motorised Opening Max. Motorlu Açılım 250 Manual Limit Stop Manuel Limit Stoplayıcı CB571
09-3012L 09-3012R		Hinges Code Makas Kodu PX0670 Max. Vent Weight (Kg) Max. Kanat Ağırlığı 200 Min. Vent Height (mm) Min. Kanat Yüksekliği 670 Max. Vent Height (mm) Max. Kanat Yüksekliği 1500 Max. Manual Opening Max. Manuel Açılım 150 Max. Motorised Opening Max. Motorlu Açılım 150 Manual Limit Stop Manuel Limit Stoplayıcı CB688
09-3013L 09-3013R		Hinges Code Makas Kodu PX0950 Max. Vent Weight (Kg) Max. Kanat Ağırlığı 200 Min. Vent Height (mm) Min. Kanat Yüksekliği 930 Max. Vent Height (mm) Max. Kanat Yüksekliği 2000 Max. Manual Opening Max. Manuel Açılım 150 Max. Motorised Opening Max. Motorlu Açılım 250 Manual Limit Stop Manuel Limit Stoplayıcı CB571

CODE / KOD	ACCESSORIES / AKSESUAR	DESCRIPTION / AÇIKLAMA
10-1100		Steel Anchorage 100 100 lük Çelik Ankraj Pieces Adet
10-1125		Steel Anchorage 125 125 lik Çelik Ankraj Pieces Adet
10-1150		Steel Anchorage 150 150 lik Çelik Ankraj Pieces Adet
10-1200		Transom Installation Model Transom Montaj Şablonu
10-1201		Mulyon Side Template Holder Mulyon Yan Tutucu Şablonu SPTH16 415 mm 1090-1500 mm 75 Kg

CODE / KOD	ACCESSORIES / AKSESUAR	DESCRIPTION / AÇIKLAMA
10-1202		Frame Side Holder Model Kaset Yan Tutucu Şablonu
10-1203		Frame Bottom Holder Model Kaset Alt Tutucu Şablonu
10-1300		Aluminium Foil Tape Aluminyum Folyo Bant Pieces (10mt) Adet (10mt)
10-3000 10-3001 10-3002 10-3003		Standart Filling Silicone 1 Pack Contains 25 Pieces Genel Amaçlı Dolgu Silikonu 1 Paketde 25 Adet Grey / Gri Transparent / Şeffaf White / Beyaz Black / Siyah
10-3010 10-3011 10-3012 10-3013		Neutral Filling Silicone 1 Pack Contains 25 Pieces Nötr Dolgu Silikonu 1 Paketde 25 Adet Grey / Gri Transparent / Şeffaf White / Beyaz Black / Siyah

ISO 9001 SERTİFİKASI



QUALICOAT SERTİFİKASI



QUALANOD SERTİFİKASI

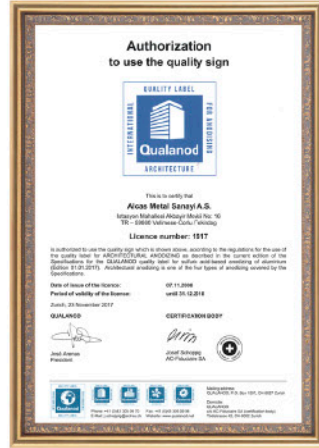

IATF 16949 SERTİFİKASI



TSE HASSAS PROFİLLER BELGESİ



TSE YÜZEY İŞLEM BELGESİ



TSE İMALATI YETERLİLİK BELGESİ



ISO 14001



OHSAS 18001 BELGESİ



FABRİKA ÜRETİM UYGUNLUK



CE BELGESİ



GOST-R SERTİFİKASI

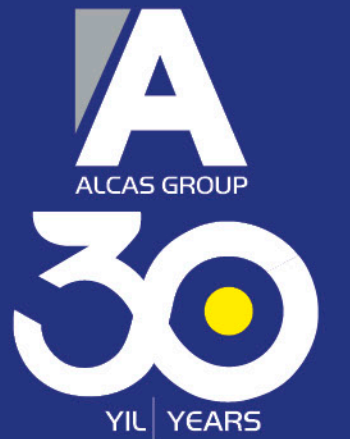

ALCAS®

ALUMINIUM PROFILE SYSTEMS

444 36 44

alcas@alcas.com.tr

www.alcas.com.tr

Kaya Milenium Plaza Kat 7 No:139 Beykent / İstanbul +90212 871 1771

Velimeşe Islah OSB 129.Sok.11/1 Ergene / Tekirdağ +90282 674 5175

alcasmetal

alcasaluminyum

alcasmetal

alcasmetal

alcasmetal



All designs, profiles and accessories listed in this catalog are © copyrighted and ® registered products. May not be copied, altered or posted online by any means.
Bu katalogta yer alan tasarımlar, profiller ve aksesuarlar tescilli ve patentli ürünlerimizdir. Hiçbir şekilde kopyalanamaz ve taktit edilemez.

Dünyanın yeni profil sistemi

